

INDEX

A-Arm Kits & Components	13	Drive Shaft Enclosure Kits	45
Access Doors	37, 44	Drive Shaft Loops	45
Aluminum Interior Kits	67	Drive Stud Kits	20
AN Fittings	34-35	Dzus Fasteners, Springs & Tabs	59-60
Anti-Roll Bar Kits	10	Electrical Components	41-42
A.R.T. Apparel & Banners	71	Engine Diaper	61
Axles		Engine Torque Limiters	44
Mark Williams	20	Fire Systems & Mounts	63
Strange	23-24	Four Link Kits & Components	7-8
Axle Bearings	19	Frame Rails	9
Axle/Spool Kits	24	Front End Mounting Kits	45
Batteries, Chargers & Components	42	Front End Travel Limiter	13
Battery Mount Kits	43	Front Suspension Systems	13
Body Mount Kit	45	Fuel Cells & Accessories	37
Brackets & Mounts	53-55	Fuel/Utility Jugs	37
Brake Kits	27	Fuel Pumps & Accessories	36
Brake Components	28-29	Relays, Gauges, Vibration Isolator	
Pads, Fluid, Lines, Fittings		Gauges	
Cables & Cable Hardware	60	Air	69
Carbon Fiber Sheets	64	Fuel	36
Carburetor Air Pan	69	Nitrous	62
Chassis & Body Components	44-45	Gear Oil	17
Chassis & Pit Accessories	61	Hardware	61
Chassis Stabilizer	61	Grade 8, AN, 10/32 Stainless	
Clamps	14, 35	Header Kits & Components	30-31
Cleco Components	68	Hood Scoop Components	69
Clevises	58	Hose, Steel & Nylon Braided	34-35
CO2 Bottles & Accessories	40	Ignition Accessories	38
Collectors	30	J Bends	31
Cross Members		Ladder Bar Kits & Components	4-6
Dropped Front & Rear	9	Lexan	46
Ladder Bar	4	Line Locks	28
Transmission	44	Master Cylinders	29
Diagonal Link Kits	10	Micro Switch Buttons & Accessories	41
Digi-Set Timers	62	Mid Plates	50
Disconnect Switches & Components	42	Motor Plates	50
Door Bar Swing Out Kits	66	Mustang Suspension Components	17
Door Bar Tube Protectors	66	Nitrous Accessories	62
Door Hinge & Release Kits	47	Panhard Bar Kit	10
Door Panel Fastener Kit	47	Parachutes & Accessories	51-52
Door Safety Strap Kits	48	Pedals and Assemblies	48-49
Door Striker Plates & Mount	47	Pinion Centering Gauges	18
Door & Window Latch Kits	47-48	Pinion Supports	
Drive Line Components	17	Mark Williams	20
Drive Shafts	17	Strange	21
		Pinion Yokes	24



Push Bar	48	Switch Panels & Components	41
Push/Pull Pins	58	Taps	58
Push Rod Kit	28	Thirdmember Assemblies.	22
RacePak Components	39	Throttle Linkage Kits	48-49
Rack & Pinions & Mount Kits	14	Tie Rod Kits	14
Radiators & Accessories	32-33	Tires	70
Rear End Components	18-19	Tire Pressure Gauges	69
Housings & Braces, Housing Ends,		Tow Hook Kit & Strap	48
Bungs, Caps & Vents, Leaf Spring Mounts,		Transmission Accessories	38
Backing Plate Bolt Kits		Dip Sticks, Tanks & Fluid	
Rear Ends-Cases		Transmission Crossmember Kits	44
Mark Williams	20	Transmission Flex Plates	38
Strange	21	Transmission Yokes	17
Ultra Case Packages	22	Tube End Adapters	58
Residual Pressure Valves	28	Tubing & Plate	56
Ring Gear Bolts	17	4130, Mild Steel, DOM	
Ring & Pinions	17	U-Joints	
Rim Screws & Template	70	Steering	15
Rod Ends	56-57	Drive Shaft	24
Roll Bars & Cages	65	U-Joint Bolts	24
Roll Cage Components.	66	Valve Stems	70
Safety Equipment	63-64	Water Pumps	33
Seats & Components	69	Weight Bars	44
Seat Belts & Mounts	63	Welding Rod.	56
Shifter Components	44	Wheel Spacers	70
Shocks	25-26	Wheel Tubs	66
Shock Mount Kits	26	Aluminum, Steel, Carbon Fiber	
Shock Washers & Bearings	25	Wheelie Bar Kits & Components	11
Spindles	16	Adjusters, Chalk, Nets, Wheels	
Mustang II, Dragster/Altered		Wheels & Accessories	70
Spools & Spool Bearings		Window Accessories.	46
Mark Williams	20	Border Paint, Cleaner, Dial-In Marker	
Strange	21	Window Frame & Installation Kits	46
Springs	25	Window Nets & Installation Kits	46
Steering Column Kits	15	Wings & Strut Kits.	68
Steering Wheels & Components	15-16	Wiring Components	41
Strut Packages & Components	12	Wishbone Kits	9

USE OF THESE PRODUCTS IS ACCEPTANCE OF SELLER'S DISCLAIMER OF WARRANTY

THE PURCHASER IS RESPONSIBLE FOR DETERMINING THE SUITABILITY AND ACCEPTABILITY OF ANY AND ALL PRODUCTS PURCHASED FROM APPLIED RACING TECHNOLOGY.

Purchaser understands and recognizes that racing parts, equipment and services provided by or manufactured and/or sold by Applied Racing Technology, are subject to varied conditions due to the manner in which they are to be installed and used. The acceptability and suitability of any part sold or manufactured by Applied Racing Technology for a particular application is solely the purchaser's decision. Applied Racing Technology makes no warranties whatsoever, expressed or implied, oral or written, THERE IS NO WARRANTY OF MERCHANTABILITY.

The right to make changes in design or add to or improve on their product without incurring any obligation to install the same on products previously manufactured is expressly reserved. Buyer agrees to indemnify and hold Seller harmless from any claim, action or demand arising out of or incident to the Buyer's installation or use of products purchased from Applied Racing Technology.

All returns must receive prior authorization, be shipped prepaid, and are subject to a 20% restocking charge. A.R.T. will not accept returns or exchanges after 30 days. Special orders must be prepaid and are not returnable. Freight charges from refused shipments will be applied to the customer's account and must be paid before further shipments will be made. All COD shipments are payable by cashier's check or money order only, made payable to Applied Racing Technology for the exact COD amount. Truck freight shipments must be prepaid (no CODs) and may include a pallet charge if applicable.

Prices subject to change without notice.

We do not accept responsibility for typographical errors in content or pricing.

Price changes are updated periodically on our online store.



REAR SUSPENSION SYSTEMS

ART PRO ADJUSTABLE LADDER BARS

A.R.T. ladder bars are 32" long, fully-welded and feature CNC-machined threads. Constructed of 1" OD x .156 wall DOM tubing, they are powder coated for a long lasting appearance. HD 3/4" x 5/8" rod ends are used at the front with safety tabs and 3/4" x 5/8" solid forged rod ends at the rear with a 4140 adjuster located in bottom bar for ease of pinion angle adjustments. Kit also comes with four 1/4" mild steel, double shear housing brackets with provisions for adjustable shock mounts and all grade 8 hardware.

- 32" Pro bar (Pair) w/mild steel rod ends** #018107 \$499.95
- 32" Pro bar (Pair) w/chromoly rod ends** #018657 \$554.95
- 32" Street Series (Pair) w/polybushed rod ends** #010011 \$574.95

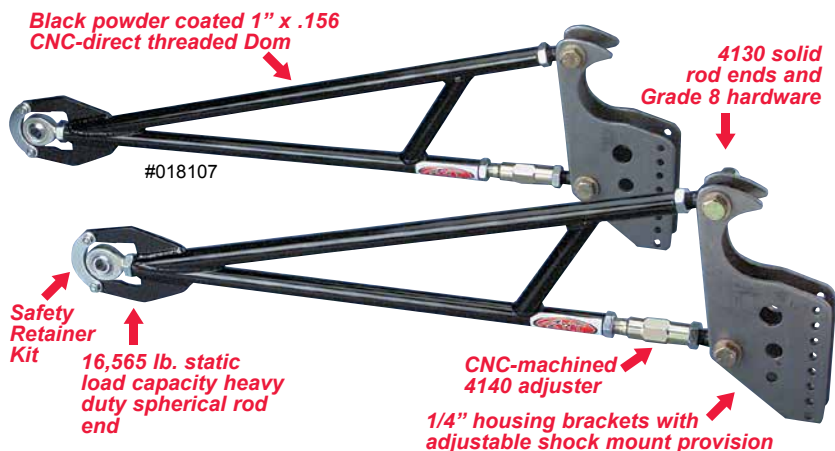

ART SAFETY TAB KIT

This kit permits the installation of rod end retention brackets onto most ladder bars to retain them in event of dangerous rod end failure.

Not intended for use with Extreme or Pro Plus Ladder Bars.

#010014 \$29.95

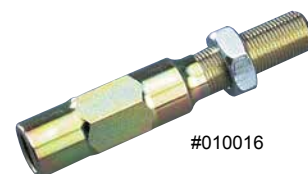

ART LADDER BAR ADJUSTER

Designed to convert any standard ladder bar into an adjustable ladder bar. Machined from 4140 material and features wrench flats for easy adjustments. Left hand jamnut is included. Requires the use of a 3/4" - 16 left hand tap to complete the conversion (each).

#010016 \$34.95

ART LADDER BAR FRONT CROSSMEMBERS

Start your chassis construction with this crossmember or use to add ladder bars to existing chassis. 60" x 1 3/4" OD x .134" tube, (4) 360°, 1/4" mild steel double shear brackets with 5 adjustment holes in round tube version. 2" x 3" version is .120" wall and features brackets with 4 adjustment holes.

- 1 3/4" round tube x .134" wall** #010000 \$109.95
- 2" x 3" rectangular .120" wall** #010001 \$144.95

Specify 5/8" or 3/4" holes.

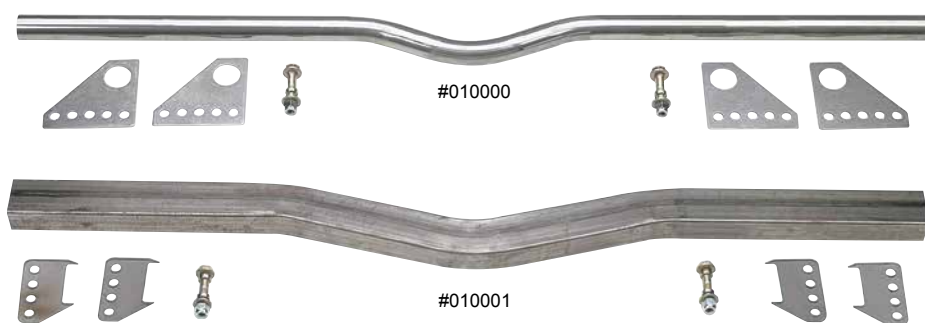

ART SOLID CHROMOLY ROD END

For ladder bar suspensions.

- | Size | Type | | |
|-------------|-------|---------|---------|
| 5/8" x 3/4" | right | #005404 | \$23.95 |
| 5/8" x 7/8" | right | #017489 | \$23.95 |



MONDAY - FRIDAY 8AM - 5PM EST
SALES: 1.800.571.3023 TECH: 727.571.3023

REAR SUSPENSION SYSTEMS

EXTREME LADDER BARS

Feature all chromoly construction, separate 1-3/8" x .095 chromoly upper and lower bars with weld-in tube adapters allowing adjustment of instant center height, pinion angle, and overall leverage. The front rod ends are 3/4" x 3/4" chromoly with safety tabs and the rear uses 3/4" x 5/8" solid rod ends. The 1/4" thick double-shear housing brackets feature two upper and two lower mounting holes for the ladder bar and provisions for adjustable shock mounts on the rear of the brackets. Can be assembled up to 36" long. **TIG welding required.**

#017384 \$749.95 (pair)



EXTREME LADDER BAR FRONT CROSSMEMBER KIT

Crossmember kit includes 60" x 1-3/4" OD x .083 chromoly tube, (4) 360°, 1/4" chromoly brackets with 3/4" holes and grade 8 bolts. **This kit is designed for use with our Extreme or Pro Plus Ladder Bar kits.**

TIG welding required.

#017456 \$174.95



PRO PLUS LADDER BARS

Feature all chromoly construction. Separate 1-3/8" x .095 chromoly upper and lower bars with weld-in tube adapters allow you to adjust instant center height, pinion angle and leverage factor. The front rod ends are 7/8" x 3/4" chromoly with safety tabs and the rear uses 7/8" x 5/8" solid rod ends. The 1/4" thick double-shear housing brackets feature three upper and three lower mounting holes for the ladder bar and provisions for adjustable shock mounts on the rear of the brackets. To increase further adjustability the Pro Plus includes the addition of two mounting hole options at the front. Can be assembled up to 36" long. **TIG welding required.**

#017579 \$799.95

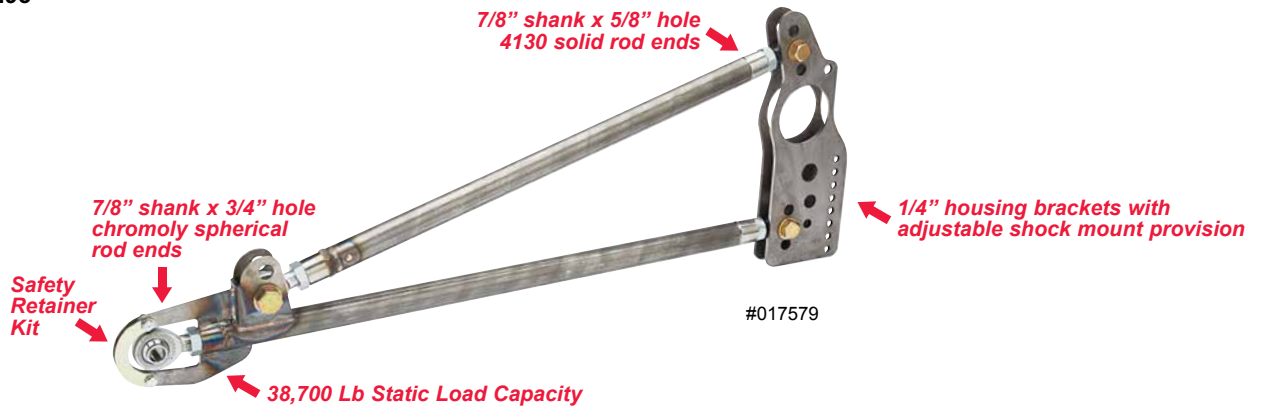

LADDER BAR SUSPENSION SYSTEM PACKAGES

EXTREME LADDER BAR SYSTEM I

Includes 36" Extreme Ladder Bars, Extreme Diagonal Link, and Extreme Crossmember Kit. **TIG welding required.**

#017457 \$1099.95

**Upgrade to Pro Plus Ladder Bars
Add \$50.00**



REAR SUSPENSION SYSTEMS



#018517

ART SYSTEM I

Strip (front heavy duty rod end) #018517 \$654.95
 Street (urethane front bushing) #018516 \$699.95

For panhard bar add \$19.95
For 2 x 3 crossmember & brackets add \$45.00



#018519

ART SYSTEM II

Sportsman System II

With Strange shocks, 10-way adjustable
 With 2x3 crossmember

#019328 \$1239.95
 #019344 \$1284.95

Pro System II

With QA1 Proma Star shocks, 18 way adjustable
 With 2x3 crossmember

#018519 \$1274.95
 #018607 \$1319.95

ART SYSTEM III

Sportsman System III with Strange shocks, 10-way adjustable

#019845 \$1699.95

Pro System III with QA1 Proma Star shocks, 18 way adjustable

#019846 \$1744.95

\$ Save Freight \$
Unwelded Kits
Ship UPS

#019845



WELDING
REQUIRED

Upgrade to billet shock mounts, add \$69.95
Upgrade to unwelded Sportsman Wishbone Kit add \$99.95
Upgrade to welded 2" x 3" frame add \$200.00

ART 4-LINK BOLT KITS



#019773

SPORTSMAN

Includes (8) 5/8-18 x 3" long bolts
 (1.275 grip/shoulder length), (16)
 5/8 grade 8 washers, (8) 5/8 nylocks.
 #019773 \$39.95



#018930

PRO

Wishbone application: For use with 3/16" thick brackets, includes (8) 5/8-18 x 1.728 long bolts (1.188 grip/shoulder length), (16) AN washers & locknuts.

#018930 \$239.95

For use with 1/4" thick brackets.

#017467 \$154.95

#019853



ART 4-LINK ASSEMBLY SPACERS

Four link assembly spacers feature correct body width to maintain proper clearance between brackets during assembly welding. (Set of 4)
 #019853 \$49.95



MONDAY - FRIDAY 8AM - 5PM EST

SALES: 1.800.571.3023 TECH: 727.571.3023

REAR SUSPENSION SYSTEMS



#019837

SPORTSMAN 4-LINK TUBE KIT

Bars are 1" OD x .156" wall DOM with CNC-machined threads for 3/4" right-hand and left-hand rod ends. Includes (2) 17-5/8" upper and (2) 18-5/8" lower bars. #019837 \$134.95



#019550

PRO 4-LINK TUBE KIT

Includes two 1-1/4" x .095 x 18" chromoly upper tubes, two 1-3/8" x .095 x 18" chromoly lower tubes, four 3/4" right-hand tube adapters and four 3/4" hex left-hand tube adapters. **TIG welding required.** #019550 \$184.95

PRO OUTLAW 4-LINK TUBE KIT

Includes four 1-1/2" x .120 x 21" chromoly bars, four 3/4" right-hand tube adapters and four 3/4" hex left-hand tube adapters. **TIG welding required.** #019867 \$269.95

PRO EXTREME 4-LINK TUBE KIT

Includes four 1-5/8" x .120 x 21" chromoly bars, four 3/4" right-hand tube adapters and four 3/4" hex left-hand tube adapters. **TIG welding required.** #017585 \$324.95

SPORTSMAN SERIES 4-LINK KITS

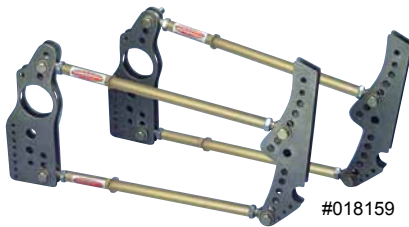

#018159

Includes 1/4" mild steel 360° double shear housing brackets with 5/8" holes. Bars are 1" OD x .156" wall DOM with CNC-machined threads RH and LH. Front brackets use arced 5/8" holes for proper geometry and ease of adjustment. Also includes grade 8 hardware.

4-link kit without rod ends	#018161	\$334.95
4-link kit with 8 3/4" mild steel rod ends	#018162	\$459.95
4-link kit with 8 heavy duty mild steel rod ends	#018159	\$674.95
4-link kit with 8 chromoly rod ends	#018160	\$899.95

PRO SERIES 4-LINK KITS



#018729

Utilizes a proven design featuring (2) 1-1/4" x .095 upper bars and (2) 1-3/8" x .095 lower bars. Left hand tube adapters have incorporated hex wrench driver. 1/4" 4130 front brackets use arced 5/8" holes. Housing brackets are 360° double shear in 1/4" 4130 with 5/8" holes. Includes grade 8 hardware. **TIG welding required.**

Pro 4-link kit without rod ends	#018729	\$639.95
Pro 4-link kit with teflon lined, stepped 5/8" x 3/4" chromoly rod ends (Aurora XAM & XAB series) and jamnuts	#010070	\$1199.95

PRO-PLUS FOUR LINK KIT

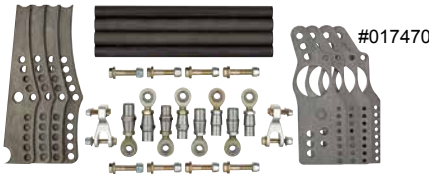

#017470

Includes 1/4" mild steel housing & chassis brackets, grade 8 bolt kit, Pro Tube Kit, and billet aluminum shock mounts. **TIG welding required.** #017469 \$499.95

Includes 1/4" mild steel housing & chassis brackets, grade 8 bolt kit, Pro Tube Kit, billet aluminum shock mounts and Aurora XM & XB mild steel rod ends.

TIG welding required. #017470 \$844.95

Upgrade to NAS Four Link Bolt Kit add \$139.95

ULTRA PRO SERIES 4-LINK KITS

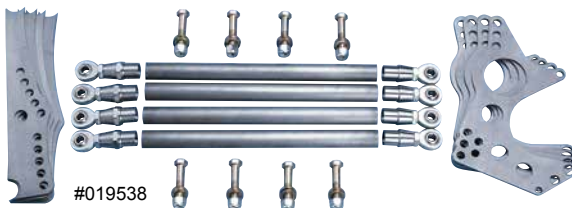

#019538

Includes 1-3/8" x .095 chromoly tubing, left hand tube adapters with incorporated hex wrench driver and 1/4" mild steel brackets with 5/8" holes. Aurora XAM & XAB series C/M rod ends are teflon-lined and feature a 3/4" shank and 5/8" ball. Includes jam nuts and grade 8 hardware. **TIG welding required.**

Ultra Pro 4-link kit with mild steel brackets #019538 \$944.95

Includes 1-3/8" x .095 chromoly tubing, left hand tube adapters with incorporated hex wrench driver and 1/4" chromoly brackets with 1/2" holes. Aurora XAM & XAB series C/M rod ends are teflon-lined and feature a 3/4" shank and 1/2" ball. Includes jam nuts and complete NAS bolt kit. **TIG welding required.**

Ultra Pro 4-link kit with chromoly brackets #019539 \$1499.95



REAR SUSPENSION SYSTEMS

4-LINK SUSPENSION SYSTEM PACKAGES

ART SYSTEM I

010095 \$399.95

With 8 heavy duty mild steel rod ends add:

Aurora \$359.60

FK \$178.40

With 8 chromoly rod ends add:

Aurora \$596.00

FK \$375.60

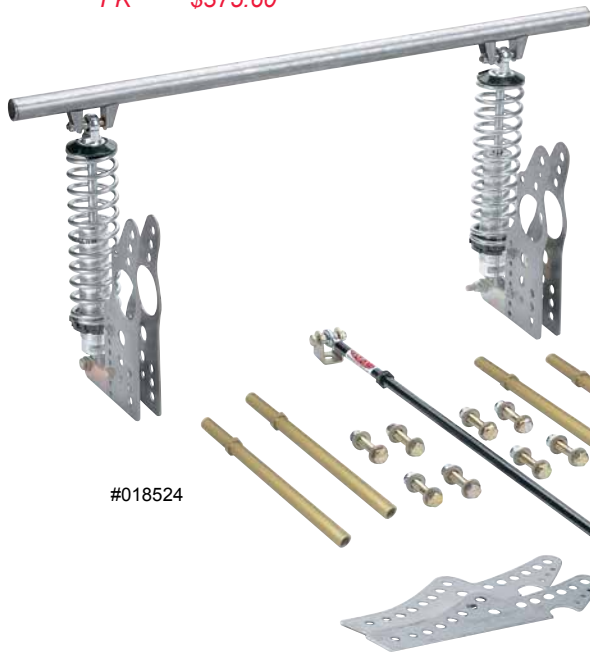

1/4" housing brackets with adjustable shock mount provision

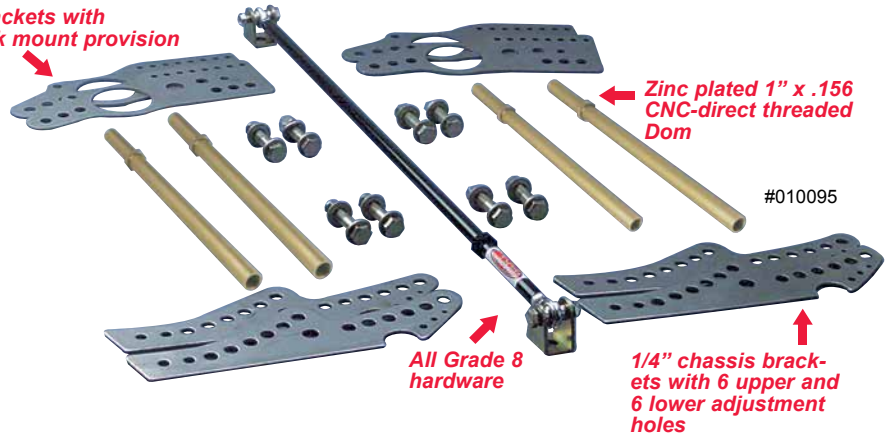

ART SYSTEM II

Sportsman System II with Strange shocks, 10-way adjustable

#019333 \$989.95

Pro 4-link System II with QA1 Proma Star shocks, 18 way adjustable

#018524 \$1029.95

With 8 heavy duty mild steel rod ends add:

Aurora \$359.60

FK \$178.40

With 8 chromoly rod ends add:

Aurora \$596.00

FK \$375.60

Upgrade to unwelded Sportsman Wishbone Kit add \$99.95
 Upgrade to billet shock mounts add \$69.95
 Upgrade System I, II or III to Chromoly Pro Tube Kit (welding required) add \$69.95

ART SYSTEM III

Sportsman System III with Strange shocks, 10-way adjustable

#019849 \$1429.95

Pro 4-link System III with QA1 Proma Star shocks, 18 way adjustable

#019850 \$1489.95

Pro 4-Link Round Tube System III with Strange shocks, 10 way adjustable

#019847 \$1399.95

With 8 heavy duty mild steel rod ends add:

Aurora \$359.60

FK \$178.40

With 8 chromoly rod ends add:

Aurora \$596.00

FK \$375.60

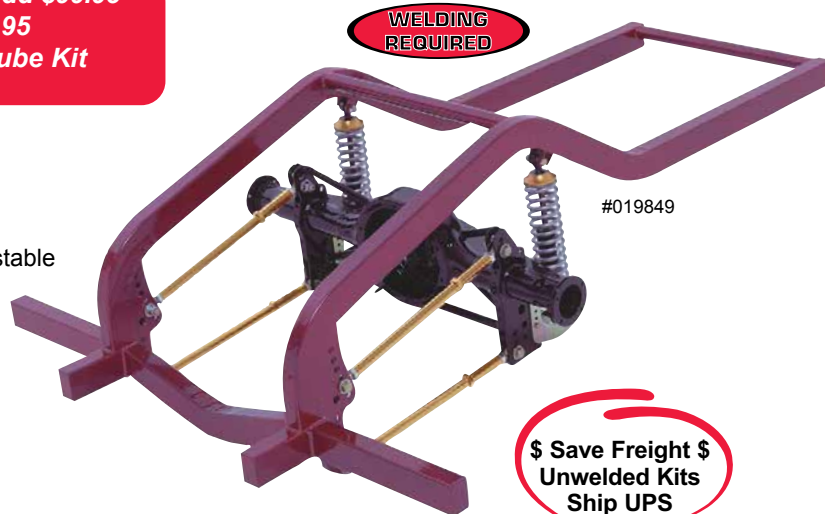

\$ Save Freight \$
 Unwelded Kits
 Ship UPS

Upgrade to welded 2" x 3" frame add \$200.00



MONDAY - FRIDAY 8AM - 5PM EST

SALES: 1.800.571.3023 TECH: 727.571.3023

FRAME RAILS & TRACK LOCATORS

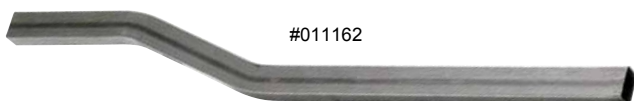

#011162



#019009



UNIVERSAL FRONT FRAME RAILS

2" x 3" x .120" wall A-arm front frame rails only (each)

#011162 \$144.95

2" x 3" x .120" wall strut front frame rails only (each)

#019009 \$144.95



#011212



DROPPED FRONT CROSSMEMBER

2" x 3" x .120" wall #011212 \$79.95



UNIVERSAL ROUND-TUBE FRAME RAILS

1 5/8" x .134" Mild Steel (each)

4-Link #019963 \$74.95

Ladder Bar #019747 \$74.95

1 5/8" x .083" Chromoly (each)

4-Link #017112 \$124.95

Ladder Bar #017113 \$124.95



#019963



#019747



#011150



#010153



UNIVERSAL REAR FRAME RAILS

2" x 3" x .120 wall Ladder Bar rear frame rails (each)

#011150 \$144.95

2" x 3" x .120 wall 4-Link rear frame rails (each)

#010153 \$144.95



#011210



DROPPED REAR CROSSMEMBERS

60" wide featuring 3.5" drop.

2" x 3" x .120"

1 3/4" x .134" m/s round tube

1 5/8" x .083" c/m round tube

1 3/4" x .083" c/m round tube

#011210 \$99.95

#011211 \$64.95

#017100 \$69.95

#017453 \$79.95

WISHBONE TRACK LOCATOR KITS

#017473



#017471

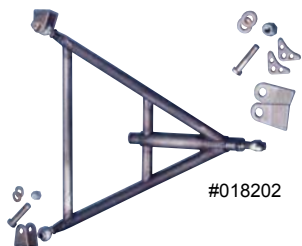
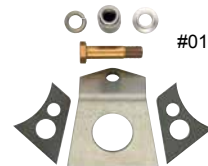

#018202

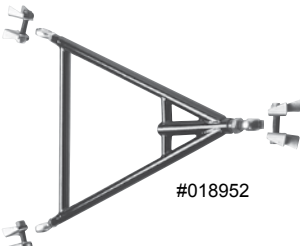

#018952

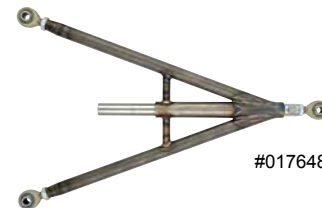

#017648

SPORTSMAN KIT/BOLT ON

Features 1" x .065", 4130 tubing, tube ends, two 1/2" mild steel rod ends, one 3/4" x 5/8" mild steel rod end and jamnuts, slider sleeve, cross brace, brackets, hardware and instructions.

Unwelded #018202 \$199.95

TIG welding required.

PROFESSIONAL KIT/WELD ON

Features all 4130 tubing and mounting brackets, two 4130 1/2" rod ends, one 4130 3/4" x 1/2" rod end and jamnuts, slider sleeve, cross brace, tube adapters and grade 8 hardware.

Unwelded #018952 \$259.95

TIG welding required.

PRO PLUS WISHBONE - WELDED

Fully welded. Includes Aurora HXAM rod ends. Designed to mount on top or bottom of rear end housing. Made for 24"-26" wide frame.

Welded # 017468 \$449.95

Pro Plus Wishbone Housing Mount

017471 \$45.95 TIG welding required.

Pro Plus Wishbone Chassis Mount

017473 \$49.95 TIG welding required.



DIAGONAL CROSSLINK & ANTI-ROLL BAR KITS

DIAGONAL CROSSLINK KITS



SPORTSMAN KITS

Kit includes choice of mild steel (5/8" or 3/4" hole), bolt on brackets, 36" x 3/4" OD x .156 wall CNC threaded DOM tube, high angularity 1/2" RH and LH mild steel rod ends with jamnuts and grade 8 hardware.

- Kit with 5/8" mounting holes #018201 \$119.95
- Kit with 3/4" mounting holes #010025 \$119.95
- Kit with 3/4" x 5/8" mounting holes #018535 \$119.95

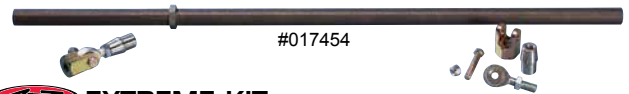

EXTREME KIT

Includes 1-1/8" x .083 wall x 36" 4130 tube, tube adapters, 1/2" R/H and L/H 4130 rod ends, jamnuts, hardware and two CNC machined mounting brackets. One bracket for use with a 5/8" bolt and one for 3/4". **This kit is designed for use with our Extreme or Pro Plus Ladder Bar kits.**

TIG welding required. #017454 \$204.95

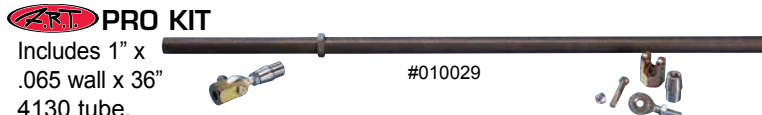

PRO KIT

Includes 1" x .065 wall x 36" 4130 tube, tube adapters, 1/2" R/H and L/H 4130 rod ends, jamnuts, hardware and CNC machined mounting brackets which feature threaded hole for use with 5/8" bolts. **TIG welding required.** #010029 \$189.95



PANHARD BAR

The #1 choice of locator design for street use. Includes frame brackets, formed rear end bracket, 3/4" RH and LH mild steel rod ends and jamnuts, 30" bar and grade 8 hardware.

#010038 \$124.95

ANTI-ROLL BAR KITS



SPORTSMAN KIT

Kit features superior needle-bearing design to eliminate bind and provide greater longevity. 1" machined tube, adjustable from 16" to 24" in width, features 6 3/4" fully assembled arms with mild steel rod ends, grade 8 hardware and mounting brackets.

TIG welding required.

#018662 \$299.95

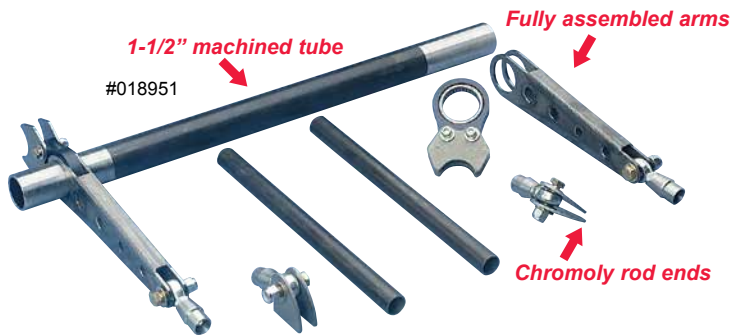

PROFESSIONAL KIT

Kit features superior needle-bearing design to eliminate bind and provide greater longevity. 1 1/2" machined tube, adjustable in width, features 8 1/4" fully assembled arms with chromoly rod ends, grade 8 hardware and mounting brackets.

TIG welding required.

With 24" Tube #018951 \$379.95

With 36" Tube #019962 \$399.95



PRO MOD KIT

Kit features spherical, self-aligning aluminum and Delrin bearing blocks, splined 7075 6" aluminum arms, adjustable width 3" center tube assembly and mounting brackets.

TIG welding required.

#019616 \$685.00

Pro Mod Installation Kit Includes 3/8" chromoly rod ends, tube adapters, tubing, mounting brackets and hardware.

#019651 \$149.95

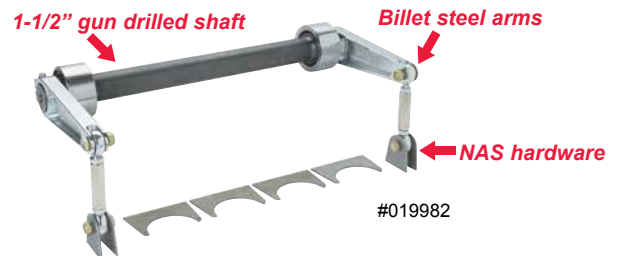

PRO OUTLAW KIT

Kit features 1-1/2" diameter 35-spline gun drilled heat-treated 4340 shaft, 6" 1045 billet steel arms, chromoly rod ends, NAS hardware and bearing assembly with mounting brackets.

16-1/8" #019835 \$719.95

18-1/8" #019982 \$719.95

20-1/8" #019836 \$719.95

Custom sizes available



MONDAY - FRIDAY 8AM - 5PM EST
SALES: 1.800.571.3023 TECH: 727.571.3023

WHEELIE BAR KITS & COMPONENTS



PROFESSIONAL KITS

Unwelded 84" dual wheel kits feature all 4130 tubing and upper crossbar with unique sleeve feature, which allows adjustment of upper bar length.



#019617

PRO MOD WHEELIE BAR KIT

Unwelded, dual wheel, 85" kit features larger 1-1/4" chromoly tubing with upper and lower sections of the bars tied together with adjustable links.

TIG welding required.

#019617 \$1199.95

PRO KIT

Features 1-1/8" x .083 upper and lower tubes with 5/8" x 1/2" aluminum rod ends with jam nuts and 4" roller bearing wheels.

TIG welding required.

#018904 \$799.95

PRO OUTLAW KIT

Features 1-1/4" x .065 upper and lower tubes with 5/8" x 1/2" chromoly rod ends with jam nuts and 4" Pro Wheelzeze roller bearing wheels.

TIG welding required.

#019764 \$1049.95

PRO MOD FOOT BOX

Chromoly wheelie bar foot box.

Uses 1/2" pin for rod end attachment.

#017409 \$74.95

Requires two gussets

#017410 \$4.50



#017409



#019231

WELDING REQUIRED

#018904



#001089

#018908

#019983

#019510

REPLACEMENT WHEELS

Sportsman 4" (1/2" hole)

Reducer sleeve 1/2" to 3/8"

Pro 4" w/roller bearing (3/8" hole)

Pro Slimline 4" w/roller bearing (3/8" hole)

Pro Wheelzeze 4" (3/8" hole)

Each

#001089 \$6.95

#019268 \$2.10

#018908 \$34.95

#019983 \$74.95

#019510 \$76.95



SPORTSMAN KITS

For those racers requiring adjustable length and width wheelie bars, these kits feature 4130 material, high impact wheels, 1/2" mild steel rod ends and jamnuts, tube adapters, brackets, grade 8 hardware and instructions.

TIG welding required.

Sportsman 4" wheels included in kits can be upgraded to Pro Roller Bearing, Pro Slimline or Pro Wheelzeze wheels for additional cost.

Unwelded kit, 60" dual wheel, spring loaded,

1-1/8" x .058 upper bars, 1-1/8" x .083 lower bars

#019231 \$549.95

Unwelded kit, 80" single wheel,

1-1/8" x .083 upper and lower bars

#018790 \$429.95

Unwelded kit, 84" dual wheel,

1-1/8" x .083 upper and lower bars

#018186 \$539.95



WHEELZEZE & CHALK PACKAGE

Includes two wheels with 3/8" hole.

Ground shipping only.

#017463 \$158.95



#017463



#017052



#017053

WHEELIE BAR RULER WRENCHES

Features 1/8" increments.

3/4" #017052 \$44.95

15/16" #017053 \$44.95



#019224



SPRING LOADED ADJUSTER

For use with 1-1/8" x .058 upper bars.

#019224 \$94.95 each

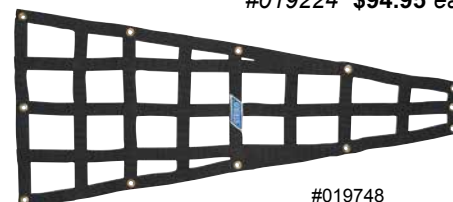

#019748

CUSTOM WHEELIE BAR NET

Prevents parachute from deploying into wheelie bars. Custom-sized to your application, specify outside tube width at top and bottom and length when ordering.

#019748 \$99.95

WHEELIE BAR CHALK

#019749

Spray-on, 10-oz. can.

Ground shipping only.

#019749 \$12.95

SALES@APPLIEDRACING.COM

ORDER ONLINE @ WWW.APPLIEDRACING.COM



FRONT SUSPENSION COMPONENTS

STRANGE STRUT PACKAGES

Strut packages include:

- Choice of spring rate
- Lower control arm kit with bearings and 1/2" chromoly rod ends
- Wheel bearings with seals and hubs with studs
- Steering arms and hardware
- Lightweight brakes do not include hubs, bearings or seals

ART STRUT SOCKET

CNC machined from billet aluminum, this tool enables proper installation of the strut by holding the strut shaft while installing the top lock nut.

#019602 \$24.95



#019602

#018491



Strut kit with **light weight** brakes, externally adjustable, 3" stroke, stud mount. Spindle mount wheels only.

Single adjustable #018489 \$1969.95

Double adjustable #019774 \$2399.95

Strut kit with **medium duty** brakes, externally adjustable, 3" stroke, stud mount

Single adjustable #018491 \$2119.95

Double adjustable #019775 \$2489.95

Strut kit with **heavy duty** brakes, externally adjustable, 3" stroke, stud mount

Single adjustable #018493 \$2289.95

Double adjustable #019776 \$2659.95



#017164

DIGITAL PROTRACTOR

#017164 \$69.95

ART STRUT CUPS

Include gussets (pair).

DOM #018763 \$89.95

Chromoly #018763CM \$99.95

TIG welding required.

#018763



#019006

STRUT KNUCKLES

For use with Strange Aluminum Struts. Features a LH and RH design with a 45° integral weld bung, 4130 chromoly male clevises, Teflon lined spherical LCA bearings, Spirolox retaining rings, and all required Grade 8 bolts, flanged locking jet nuts, and 3AN washers.

TIG welding required.

#019006 \$154.95 (pair)

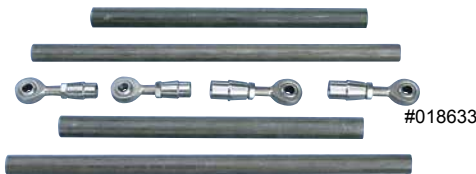

#018633

ART STRUT LOWER CONTROL ARM KIT

This kit comes complete with tube adapters, 4130 chromoly tubing, all necessary mounting hardware and 1/2" chromoly rod ends. **TIG welding required.**

#018633 \$174.95 (pair)



#017486

STRUT KNUCKLE STUDS

Compatible with all models of Strange Struts and lower control arm kits.

#017486 \$69.95 (pair)

#019028



STRUT CONTROL ARM MOUNT KITS

Includes 8 mounting brackets, NAS bolts and necessary hardware.

Sportsman w/mild steel brackets #019987 \$69.95

Pro w/chromoly brackets

TIG welding required. #019028 \$84.95

#019831



BILLET STRUT CONTROL ARM MOUNT KIT

Pre-notched 4130 chromoly, features 360-degree mounting surface, set of four with NAS hardware.

TIG welding required.

#019831 \$289.95



MONDAY - FRIDAY 8AM - 5PM EST

SALES: 1.800.571.3023 TECH: 727.571.3023

FRONT SUSPENSION COMPONENTS

ART STRUT FRONT SUSPENSION SYSTEMS

These unwelded kits feature 2 x 3 mandrel-bent frame rails, Strange stud-mount externally adjustable struts with springs and medium duty brakes, Pinto style rack and pinion, billet rack mount, 4130 lower control arms with 4130 rod ends and mounting brackets, upper strut bars, diagonal bars, strut cups, strut cup locating fixtures, front crossmember and grade 8 hardware. Custom widths available.

Strut front suspension system #019851 \$3499.95

Other strut & brake combinations available, price varies per selected components.

Upgrade to welded Strut Front Suspension add \$350.00



ART A-ARM FRONT SUSPENSION SYSTEM

These unwelded kits include 2 x 3 mandrel-bent frame rails and front crossmember, QA1 ProMa Star 18-way adjustable shocks with springs, Pinto style rack and pinion, billet rack mount, Mustang II spindles, fixture-welded upper and lower a-arms with screw-in ball joints and poly bushings and grade 8 hardware. Custom widths available.

#019852 \$2999.95

Upgrade to welded A-Arm Front Suspension System add \$400.00

TUBULAR A-ARMS & TRAVEL LIMITER KITS



ART MUSTANG II TUBULAR A-ARM KIT

This powder coated kit is designed for use with A.R.T. frame rails and bracket kit, and includes screw-in ball joints.

#018707 \$799.95



T.R.Z. TUBULAR A-ARMS

- | | | |
|---|---------|-----------------|
| '67 - '69 Camaro, '68 - '74 Nova, stock width | #019758 | \$950.00 |
| '64 - '72 Chevelle, stock width | #019759 | \$950.00 |
| '78 - '88 G-Body, stock width | #017023 | \$950.00 |
| '70 - '81 Camaro, '75 - '79 Nova, stock width | #019760 | \$950.00 |
| '83 - '02 S-10, Blazer, stock width | #019761 | \$950.00 |

NOTE: True coilover applications available, call for information.

ART FRONT END TRAVEL LIMITER

Designed for use with either a-arms or struts, the kit is easily adjustable and comes complete and ready for installation.

#018649 \$74.95



ART TUBE STYLE FRONT END TRAVEL LIMITER

Made from 4130 Chromoly tubing. Includes all tube adapters, rod ends and Grade 8 hardware.

TIG welding required.

#017429 \$179.95



STEERING COMPONENTS

RACK & PINIONS

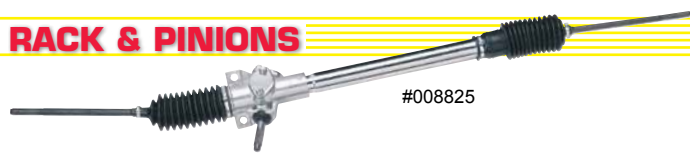

'71-'72 PINTO STYLE

These Flaming River units feature chrome body with polished aluminum housing, 1/2" RH SAE tie rod end threads.

Standard (overall length 45-1/2") #008825 \$239.95

5" Narrowed #019796 \$299.95

A.R.T. Rack & Pinion Package:
Standard Pinto Rack & Pinion, Rack Mount & Sportsman Weld-on or Thread-on Tie Rod Kit \$394.95



PINTO BILLET CLAMP RACK MOUNT

Mounts '71-'72 style racks to 1 1/4" O.D. tubing.

#018135 \$89.95

Billet clamp only without brackets or hardware

#019073 \$79.95

PINTO RACK & PINION BELLOWS

#008827 \$69.95



T-BOLT BAND CLAMPS-STAINLESS STEEL

Required by sanctioning bodies for bottle mounts, dragster motor mounts, etc.

1 1/4" - 1 3/8" #018248 \$4.50

1 1/2" - 1 3/4" #001701 \$3.75

1 5/8" - 1 7/8" #001702 \$4.95



STRANGE PRO BOX RACK & PINION

- 24.50" Clevis centers
- 3 Turns lock-to-lock
- Adjustable mounting system adapts to a variety of chassis designs

#017351 \$694.95



PRO BOX TIE ROD KIT

Features 5/8" x .120 x 12" chromoly tubes and 7/16" chromoly rod ends. Four press-in reducer bushings are included for the two rod ends which ride in the rack clevises allowing for an increased range of movement without binding.

Requires 7/16" left and right hand taps (see page 53).

#017352 \$169.95

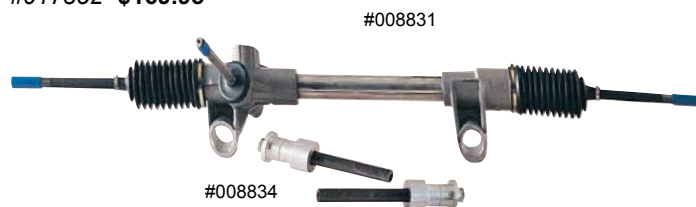

'74-'78 MUSTANG II (2 HOLE MOUNT)

Same basic design as '71-'72 Pinto except uses 2 hole mounting (see kit listed below.)

Standard #008831 \$299.95

Mounting kit for '74 - '78 Mustang II #008834 \$84.95

Mustang II Bellows #018582 \$69.95

A.R.T. Tie Rod Kits are not compatible with this rack.

DRAGSTER RACK & PINION

#008847 \$394.95



TIE ROD KITS



SPORTSMAN WELD-ON

This kit forms a sleeve which is welded to the stock Pinto tie rods to adapt them to any number of applications and chassis widths. Kit includes 2 tubes with CNC-machined threads and 2 spherical rod ends with high angularity bushings.

A-Arm - 1/2" Bolts #008785 \$84.95

Strut - 3/8" Bolts #019581 \$84.95

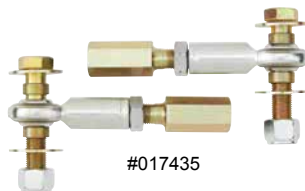

SPORTSMAN THREAD-ON

Thread on tie rod kit for use with Pinto style racks using 1/2" - 20 thread.

Sold as pair.

A-Arm - 1/2" Bolts #017435 \$84.95

Strut - 3/8" Bolts #019800 \$84.95



PRO

Features high angularity chromoly rod ends, 7/16" shank with 3/8" ball and includes all necessary grade 8 hardware. Sold as pair.

#018939 \$169.95

Weld-on tie rod kits for use with standard pinto rack only



MONDAY - FRIDAY 8AM - 5PM EST

SALES: 1.800.571.3023 TECH: 727.571.3023

STEERING COMPONENTS



#018198

SPORTSMAN STEERING COLUMN KIT w/ mounting hardware

Includes 6061-T6 aluminum column tube, aluminum bushings, chromoly tubing, steering wheel mount with U-joint and splined Pinto rack coupler.

TIG welding required.

#018198 \$199.95

Steering Wheel and Column Package
#017318 \$329.95

SPORTSMAN LOWER STEERING SHAFT SUPPORT

Designed to slide over 3/4" steering shaft to eliminate binding and is required when two or more U-joints are employed in the steering column set-up.

#019410 \$25.95



#019410



#019619

PRO STEERING COLUMN KIT w/ mounting hardware

Includes Delrin bushings, chromoly tubing, Apex joint, splined Pinto rack coupler, and Mark Williams SFI quick-release five bolt steering hub.

TIG welding required.

Single Apex application #019619 \$449.95

Dual Apex application #019620 \$589.95

PRO LOWER STEERING SHAFT SUPPORT

This assembly is required on all dual u-joint or Apex applications, and includes chromoly chassis mounting tube and bushing housing with two bushings.

TIG welding required.

#019854 \$28.95



#019854

STEERING COLUMN FIREWALL BOOT

3/4" ID x 3" OD.

#019750 \$20.95



#019750

U-JOINTS

APEX U-JOINTS

Mil-Spec Apex u-joints are pre-lubricated and sealed against the elements and feature 3/4" ID tubes (7/8" OD).

#019367 \$124.95

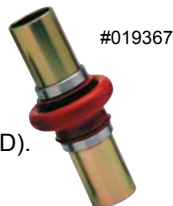

#019367

STEERING U-JOINTS / NEEDLE BEARING

3/4" bore H.D. U-joint

#008760 \$63.95

3/4" bore, 9/16" x 26 spline U-joint

#008761 \$67.95

3/4" bore, 5/8" x 36 spline U-joint

#008762 \$67.95

3/4" bore, 3/4" x 30 spline U-joint

#008763 \$67.95

3/4" bore, 3/4" x 36 spline U-joint

#008764 \$67.95

Pinto splined female adapter, 9/16" x 26

#008773 \$21.95



#008760

#008773

STEERING WHEELS & ACCESSORIES



#008727

DOORSLAMMER STEERING WHEEL

Padded grip ring and 5-bolt design.

13" diameter.

#008727 \$109.95



#019566

PRO STOCK STEERING WHEEL

13" diameter, center line graphic, textured grip, 5-bolt design.

#019566 \$129.95

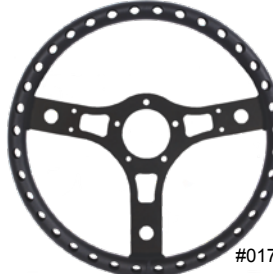

#017445

LIGHTWEIGHT ALUMINUM STEERING WHEEL

13-Inch diameter, black anodized, 5-bolt design, multiple button mounting provisions.

Flat wheel center machined from 6061-T6

#017445 \$149.95



#017630

PRO PLUS SUEDE STEERING WHEEL

Features a 13" diameter, hand stitched suede, black anodized aluminum structure, red leather centering stripe, Grant 5-bolt design, and machined slots used for universal micro switch mounting.

#017630 \$139.95

Extreme Steering Wheel Package
Includes LW Aluminum wheel, two buttons with cords,
& Mark Williams SFI quick-disconnect hub.
#017602 \$399.95



SALES@APPLIEDRACING.COM
ORDER ONLINE @ WWW.APPLIEDRACING.COM

STEERING COMPONENTS

STEERING WHEEL HUB EXTENSIONS

NHRA-accepted, this billet extension mounts to a 5-hole quick-disconnect hub at one end and a Grant-style wheel at the other. This dual-purpose configuration can be used to either extend the steering wheel location or with steering column modification, to allow more driver space when the steering wheel is removed.

3" Extension #019855 \$119.95
5" Extension #019856 \$139.95



#018222

ECONO 3 BOLT QUICK RELEASE ADAPTER

Hex style w/integral pin release, 3/4" bore on shaft adapter.
#018222 \$32.95



#017315

ART DRAGSTER STEERING WHEEL HUB EXTENSION

NHRA accepted, this billet extension mounts to a 4-hole quick-disconnect hub at one end, and a butterfly-style wheel at the other.

3" Extension #017315 \$109.95



#018515



#008746



#008744

ART STEERING WHEEL ADAPTER 5-to-3 HOLE

Designed to allow installation of the 5-hole Grant wheel on a 3-hole quick-disconnect. Includes hardware.

4130, not for use with Hub Extensions #019027 \$14.95

Billet, not for use with Hub Extensions #017025 \$44.95

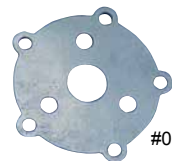

#019027



#017025

PRO QUICK RELEASE STEERING WHEEL MOUNTS

Fine spline w/integral collar type (Indy car) release, 4 & 5-bolt styles, 0 tolerance (no slop), 3/4" bore on shaft adapter.

5-bolt Grant wheel, Strange SFI #018515 \$119.95
Horn button for above, A.R.T. Logo #017381 \$15.95
5-bolt Grant wheel, Mark Williams, SFI #008746 \$154.00
4-bolt Dragster, SFI #008744 \$120.00

MICRO SWITCH MOUNTS

Grant Wheel Pro

#018791 \$29.95

Grant Carbon Fiber

#019081 \$59.95



#019081



#018791

BILLET STEERING WHEEL HOOK

For 1-5/8" tubing, black anodized

#017532 \$19.95



#017532

SPINDLES & COMPONENTS

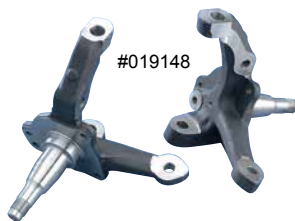

#019148

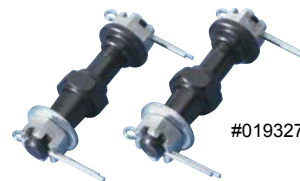

#019327

TIE ROD REPLACEMENT STUDS

Machined at one end to match the taper of the Mustang II spindle, and at the other end to accept a 1/2" spherical rod end. Pair.

#019327 \$59.95

'74-'78 MUSTANG II SPINDLES

These spindles accept stock or after-market components and are new forgings, not re-manufactured (pair).

#019148 \$299.95

DRAGSTER/ALTERED SPINDLES

Spindles come with heat treated and ground king pins, king pin bosses, 5" steering arms, billet caps and zerk fittings.

#008880 \$424.95



#008880



MONDAY - FRIDAY 8AM - 5PM EST

SALES: 1.800.571.3023 TECH: 727.571.3023

DRIVE LINE COMPONENTS

STRANGE MUSTANG STRUTS

Steel construction, externally adjustable, 10 rebound settings.
 '87-'93 #019554 \$148.95 each
 '94-'04 #019555 \$148.95 each
 '05-'10 #017149 \$168.95 each



#019554



#019762

STRANGE MUSTANG STRUT COILOVER KIT

For use with Strange Mustang Struts, features aluminum body, spring seats, jam nut and bearings.
Must use after-market caster/camber plates.

#019762 \$178.95 (pair)

DIRECT DISTRIBUTOR FOR UPR MUSTANG SUSPENSION COMPONENTS



RING GEAR BOLT KITS

7/16" Sportsman Grade 8 #018214 \$12.95
 7/16" Pro 12 point #010335 \$32.95
 1/2" Pro 12 point drilled #015052 \$69.95

9" FORD RING & PINIONS

4.11 Standard #018245 \$369.95
 4.30 Standard #018246 \$399.95
 3.89 Pro #019141 \$649.95
 4.11 Pro #018779 \$649.95
 4.29 Pro #018885 \$649.95
 4.57 Pro #018780 \$649.95
 4.86 Pro #019294 \$649.95

NOTE: Other applications and ratios available, call for pricing.



#018885

#018593



GEAR OIL

1 quart of 85W140
 #018593 \$22.95

9 1/2" FORD RING & PINIONS

Drag race use only, 35 spline pinion.

3.89 Ratio #017396 \$749.95
 4.11 Ratio #017397 \$749.95
 4.29 Ratio #017398 \$749.95
 4.56 Ratio #017399 \$749.95



#017396



10" FORD RING & PINIONS AVAILABLE, PLEASE CALL

TRANSMISSION YOKES

STRANGE STANDARD TRANSMISSION YOKES

Turbo 400 32-spline (1350) heavy duty #010950 \$114.95
 Powerglide 27-spline (1350) heavy duty #010952 \$114.95



#018115

MARK WILLIAMS BILLET 4340 TRANSMISSION YOKES

Powerglide, 27-spline, 1350 joint #018115 \$235.00
 Powerglide with roller bearing tail shaft, 27-spline, 1350 joint #018973 \$235.00
 Turbo 400, 32-spline, 1350 joint #010901 \$235.00
 Mopar, 30-spline, 1350 joint #010902 \$235.00
 Lenco, 16-spline, 1350 joint #010903 \$235.00
 Lenco, 32-spline, 1350 joint #010904 \$235.00

PST CHROMOLY DRIVE SHAFT ASSEMBLY

3-1/2" diameter, .083 wall, 1350 series solid u-joints that are designed for the stresses of drag racing. Chromoly driveshafts are able to be SFI certified at an additional cost. **Price does not include transmission yoke.**

#017320 \$689.95

#017321



PST CARBON FIBER DRIVE SHAFT ASSEMBLY

3-3/4" diameter, 1350 series u-joint with 7075 forged tube yokes. Meets SFI spec 43.1.

Price does not include transmission yoke.

#017321 \$1249.95



SALES@APPLIEDRACING.COM
 ORDER ONLINE @ WWW.APPLIEDRACING.COM

REAR END COMPONENTS

9" FORD REAR END HOUSINGS



#010106

STRANGE HD 9" HOUSING

Features DOM 3-1/4" x .250 wall axle tubes.
Housings do not include ends, mounts, drain or fill.
#010106 \$499.95



#017353

9" HOUSING PACKAGES

These unwelded packages include Strange HD 9" housings with 3-1/4" x .250 wall axle tubes, rear brace, small weld bung & fill cap with rear end drain kit.

- 40" Strange housing #017353 \$599.95
- 50" Strange housing #017354 \$609.95
- 60" Strange housing #017355 \$619.95



AXLE HOUSING TUBING

- 3-1/4" x .188 DOM, per foot #50 \$49.95
- 3-1/4" x .250 C/M, per foot #27 \$59.95



#010110

9" HOUSING BRACES

For 3-1/4" axle tubes and centered pinion. Final fitting and welding required.

Strange HD Housing, 40" tube end to tube end #017356 \$84.95

Strange HD Housing, 50" tube end to tube end #017357 \$94.95

Strange HD Housing, 60" tube end to tube end #017358 \$104.95

Stock housing with bump cover, 40" tube end to tube end. #010110 \$79.95

3-1/2" Axle Tubes Available

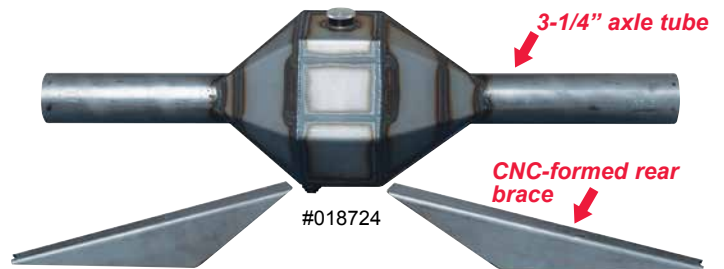

#018724

FABRICATED HOUSING WITH REAR BRACE & TUBES

3-1/4" tubes, drain & fill, precision ground mounting plate and internal bulkhead bracing.

- Mild steel 40" #018724 \$774.95
- Mild steel 50" #018724L \$844.95
- Mild steel 60" #018724XL \$899.95
- Chromoly 40" #010107 \$899.95 TIG welding required.
- Chromoly 50" #010107L \$974.95 TIG welding required.
- Chromoly 60" #010107XL \$1019.95 TIG welding required.

#019973

SPORTSMAN PINION CENTERING GAUGE

Don't guess - use this to determine the correct housing width the first time! For 9" Ford only.
#019973 \$14.95



#019609

PRO PINION CENTERING GAUGE

For 9" Ford, Dana 60, 12-Bolt and Olds / Pontiac.
#019609 \$24.95



#018674



LEAF SPRING HOUSING MOUNT

For leaf spring applications with 3" axle tubes. Pair.
#018674 \$19.95



MONDAY - FRIDAY 8AM - 5PM EST

SALES: 1.800.571.3023 TECH: 727.571.3023

REAR END COMPONENTS

BEARINGS, RETAINERS & HOUSING ENDS



AXLE BEARINGS

Mopar non-adjustable with removable ring (each)	#018672	\$59.95
1.772" bore, 3.150 housing end (each)	#018580	\$49.95
1.531" bore, 3.150 housing end (each)	#015891	\$49.95
1.562" bore, 3.150 housing end (each)	#018568	\$49.95
Small Ford with retainer plate, 1.562" bore, 2.835 housing end (each)	#018260	\$59.95
Single row sealed 1.774" bore, 3.150 housing end (pair)	#010839	\$114.00

NOTE: There are many axle bearing sizes and styles available. Please call for assistance in determining the correct bearing for your application.



REAR END FILL BUNGS, CAPS & VENTS

Steel filler bung, small	#010346	\$14.95
Steel filler bung, large	#019174	\$15.95
Alum. filler bung, small, OD 1 ⁵ / ₈ ", ID 1 ³ / ₈ "	#018829	\$11.50
Alum. filler bung, large OD 2 ¹ / ₂ ", ID 2"	#010347	\$16.50
Alum. filler cap, small, OD 1 ⁷ / ₈ "	#010348	\$18.95
Alum. filler cap, large, OD 2 ³ / ₄ "	#015011	\$32.95
1/8" NPT vent	#010349	\$7.95
Rear end drain kit	#018899	\$10.95



HOUSING ENDS

These housing ends are precision machined for each application. Sold in pairs.

Olds '57-'64 1"	#015730	\$76.50
Olds '57-'64 2"	#010256	\$124.00
Big Ford (Early) 1"	#015733	\$76.50
Big Ford (Early) 2"	#010257	\$130.00
Big Ford (Late) 1"	#018883	\$139.95
Small Ford (Early Mustang) 1"	#015732	\$76.50
Small Ford (Early Mustang) 2"	#010258	\$124.00
Lamb (Symmetrical) 1"	#019414	\$149.95
Lamb (Symmetrical) 4130 2"	#010260	\$156.95
TIG welding required.		
Mopar 1"	#015731	\$76.50
Small GM 2"	#010261	\$143.00
Large GM 2"	#010262	\$166.00

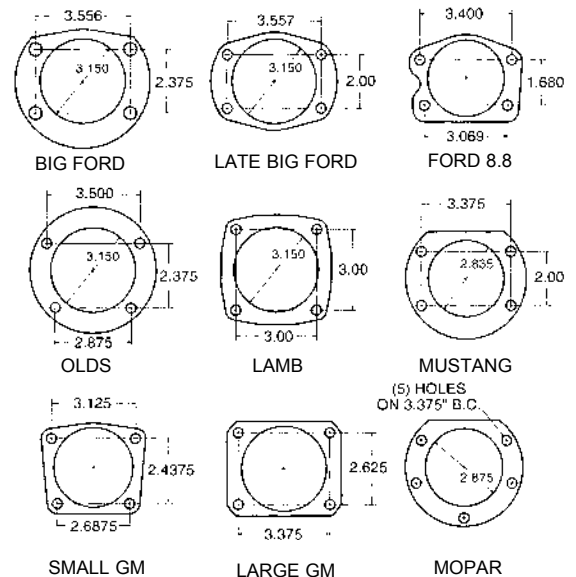

HOUSING END BACKING PLATE & THIRDMEMBER ATTACHMENT BOLT KITS



ART 9" FORD STUD KIT
Set of 10 bolts, locknuts and washers
#015010 \$44.95



3/8" BACKING PLATE BOLTS
Shouldered, set of 8 with nuts.
#010278 \$39.95
3/8" BACKING PLATE BOLTS
Shouldered, set of 10 with nuts.
#015014 \$41.95



ART 1/2" BACKING PLATE BOLTS
Shouldered, set of 8 with nuts, for large Ford ends.
#010279 \$49.95



REAR END COMPONENTS

#010602

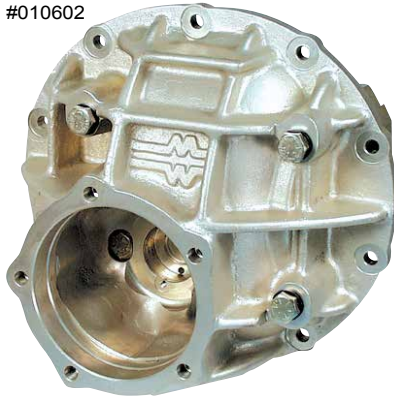

MARK WILLIAMS 9" FORD CASES

9" Ford Aluminum Thru-bolt Case 3.250 bore with aluminum caps and adjusters, weight 16.5 lbs.

#010602 **\$969.00**

9" Ford Aluminum Thru-bolt Case 3.812 bore with aluminum caps and adjusters, weight 16.2 lbs. Will accept 9-1/2" ring gear.

#010605 **\$958.00**

MARK WILLIAMS PINION SUPPORTS

Pinion Bearing Housing Assembly

Taper Timken bearings, 9" Ford standard pinion 28-spline, requires M-W U-joint yoke or coupler (stock yoke must be modified).

#018302 **\$387.00**

Pinion Bearing Housing Assembly

Taper Timken bearings, 9" Ford large pinion 35-spline gears, uses special M-W U-joint yoke or coupler.

#010332 **\$380.00**



#018302



#010404LW

MARK WILLIAMS FORGED STEEL SPOOLS

9" Ford Spools M-W 40-spline, 3.250" bore case
(58505 wheel bearing and proper housing ends are required)

M-W 35-spline, for 3.250" bore case

Weight
8.5 lbs.

Profile Milled
#010404LW **\$365.00**

9 lbs.

#010412LW **\$365.00**

NOTE: 3.812 case lightweight steel spools, as well as aluminum and titanium spools are available.



#015023

5/8" DRIVE STUD KITS

Strange universal 3" kit with sleeves and spacers

M/W 2-11/16" CM stud	#015022	\$154.00
M/W 2-7/8" CM stud	#015023	\$154.00
M/W 3-7/16" CM stud	#015024	\$154.00
M/W 3-1/2" CM stud	#010241	\$154.00
M/W 4" CM stud	#015021	\$154.00

A-Dimension

B-Dimension

C-Dimension

D-Dimension

2-11/16"

1"

7/8"

13/16"

2-7/8"

7/8"

1-3/16"

13/16"

3-7/16"

7/8"

1-3/4"

13/16"

3-1/2"

1-3/16"

1-1/2"

13/16"

4"

1-3/16"

2"

13/16"

MARK WILLIAMS AXLES

STANDARD "HI-TORQUE" AXLES

#010180 Starting at \$696.00 per pair.

SUPER LIGHT "HI-TORQUE" AXLES

#019568 Starting at \$853.00 per pair.



#019568

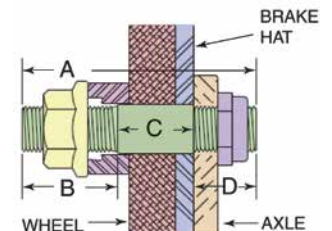



#010618

STRANGE 9" FORD CASES

- Strange 9" S-Series nodular case w/iron caps & steel adjusters**
- 3.062" bearing #019943 \$288.95
- 3.250" bearing #019944 \$288.95
- Strange/Ford nodular case w/steel caps & adjusters, 3.062" bearing** #010612 \$368.95
- Strange/Ford nodular case w/steel caps & adjusters, 3.250" bearing** #010614 \$368.95
- Strange/Ford 9" aluminum case w/caps & adjusters, 3.062" bearing** #010616 \$488.95
- Strange/Ford 9" aluminum case w/caps & adjusters, 3.250" bearing** #010618 \$488.95

STRANGE PINION SUPPORTS

- Standard pinion support only #018064 \$149.95
- Assembly kit, 28 spline #018065 \$104.95
- Assembly kit, 35 spline #018066 \$104.95



#018064



#018065

#010480



SPOOL BEARING SETS

- Dana 60 spool #010480 \$68.95
- 12-bolt Chevy & '63-'80 Corvette spools #010481 \$44.95
- 9" Ford spool using 2.891" bore case #010483 \$49.95
- 9" Ford spool using 3.062" bore case #010484 \$49.95
- 9" Ford 35 and 40 spline spool using 3.250" case #010485 \$49.95
- 9" Ford 35 and 40 spline spool using 3.812" case #017603 \$64.95

STRANGE FORGED STEEL SPOOLS

Strange spools are forged in Strange-designed tooling from chromoly steel. These forgings are machined on all critical surfaces by computer controlled lathes. Mounting holes are drilled and axle splines are precision broached before heat treating. After heat treating, bearing and gear mounting areas are finish ground to precise tolerances.

- Dana spool for 3.54, 3.73 & 4.10 ratio gear set - 35 spline #010438 \$274.95
- Dana lightweight spool for 4.56-7.17 ratio gear set - 35 spline #010439 \$274.95
- Chevy 12-bolt lightweight spool - 33 spline #010440 \$224.95
- Chevy 12-bolt lightweight spool - 30 spline (must be used w/safety hub kit) #010444 \$197.95
- Ford lightweight spool - 31 spline #010446 \$197.95
- Ford lightweight spool - 33 spline #010448 \$224.95
- Ford lightweight spool - 35 spline #010450 \$197.95
- Ford lightweight spool - 8.8 33 spline #010456 \$197.95
- Ford lightweight spool - 40 spline #010458 \$294.95



#010450



REAR END COMPONENTS

#017385



COMPLETE STRANGE 9" FORD THIRDMEMBER ASSEMBLIES

9" Ford Thirdmember Assembly

Nodular case, LW spool up to 35 spline,
3:50 to 6:50 Pro Street gear with yoke.

#017385 \$1464.95

9" Ford Thirdmember Assembly

Aluminum case, LW spool up to 35 spline,
3:50 to 6:50 Pro Street gear, with yoke

#010642 \$1588.95

9" Ford Thirdmember Assembly

Aluminum case, LW spool up to 35 spline,
4:11 to 4:86 competition large stem gear, with yoke

#010638 \$1834.95

9" Ford Thirdmember Assembly

Aluminum case, LW 40 spline spool,
5:00 to 6:50 competition gear, with yoke

#010634 \$1872.95

Assemblies also available with nodular case and posi units.

#010642

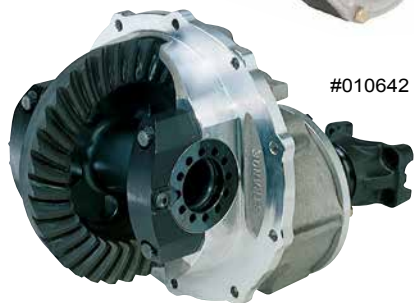

STRANGE ULTRA CASE PACKAGES

Kits include pinion bearings and caps, pinion bolts, pinion depth shims, pinion seal, pinion nut, side bearings and cups, ring gear bolts and tail bearing with retainer.

Other packages available - call for info and pricing.

#018976



3.250 Large pinion #018946 \$1294.95

3.812 Large pinion #018976 \$1359.95

3.812 Ball bearing, large pinion #018977 \$1494.95



STRANGE ULTRA CASE ASSEMBLY

3.812 bore, Ultra Case, fully assembled with lightweight
40 spline spool, billet aluminum pinion support,
3.89 - 4.86 large-stem Pro gear set with chromoly yoke.

#019564 \$2219.95

• Various other Ultra Case Assemblies & options available.

#019564

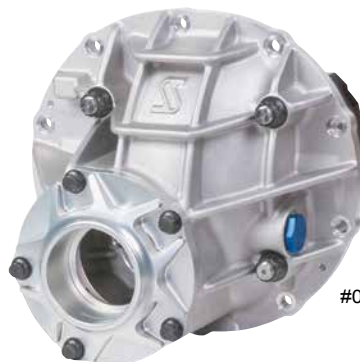

#017319

STRANGE THRU-BOLT ASSEMBLY

3.250" bore, includes Pro HD aluminum case, billet
aluminum pinion support with 7/16" ARP bolts, pinion
depth shims and large tail bearing with retainer plate.

#017319 \$874.95



REAR END COMPONENTS

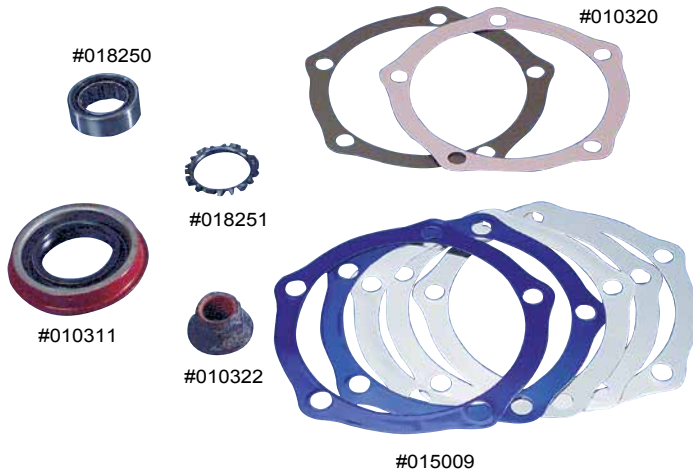

9" FORD SERVICE PARTS

3rd member gasket Sportsman	#010310	\$5.95
3rd member gasket Pro	#019838	\$22.95
Pinion seal, 28 spline	#010311	\$12.75
Pinion seal, 35 spline	#010312	\$21.95
Pinion shim set 3/8"	#010320	\$15.25
Pinion shim set 7/16"	#015009	\$23.95
Pinion nut, 28 spline	#010322	\$5.25
Pinion nut, 35 spline	#010323	\$6.75
Adjuster locks (pair)	#010324	\$5.95
Pinion tail bearing	#018250	\$34.95
Pinion tail bearing retainer	#018251	\$3.95

STRANGE S/S STREET AXLE PACKAGES

9" Ford

Strange S/S Street axles (pair), axle bearings, 1/2" stud kit and retaining plates. #018691 \$489.95

8.8" Ford

Strange S/S Street axles (pair), axle bearings 1/2" stud kit and C-clip eliminator. #018692

Pricing based on application



#018694

STRANGE S/T SERIES AXLE PACKAGES

Includes Strange S/T Series axles (pair), axle bearings and retaining plates.

With 1/2" studs #018694 \$489.95

With 5/8" studs #018695 \$549.95

STRANGE "HY-TUF" AXLES

5 yr. Warranty on 35 to 40 Spline Axles. "Hy-Tuf" alloy steel was originally developed for highly stressed landing gear on military aircraft. This high nickel alloy steel is forged, using Strange-designed tooling, giving the axle forging the correct density and grain structure. "Hy-Tuf" axles have become a standard in all forms of competition.

NOTE: • Lightening holes in axles (pair) add \$40.00

• Pocket mill axle flange (pair) add \$100.00 • Gun drilled axles (pair) add \$140.00

Many popular axle lengths in stock for immediate shipment! Studs not included.

Any length & bolt circle, up to 35 splines (pair) #0175xx plus length \$479.95

Any length & bolt circle 40 spline (pair) #017600 \$525.95



#017517



#017600



REAR END COMPONENTS



STRANGE AXLE KITS

For the racer who needs both spool and axles, these kits provide the advantage of package pricing.

For 5/8" stud kit instead of 1/2" add \$60.00

		WITH SPOOL	WITHOUT SPOOL
Chevy 12-Bolt	Strange Pro-Race 30 or 33 spline axles, light weight spool, C-clip eliminator kit and 1/2" stud kit.	#018683 \$684.95	#018683NS \$589.95
Ford 9" Small Bearing	Strange Pro-Race 33 or 35 spline axles, light weight spool, axle bearings with retainer plates and 1/2" stud kit.	#018684 \$784.95	#018684NS \$539.95
Ford 9" Large Bearing	Strange Pro-Race 33 or 35 spline axles, light weight spool, axle bearings and 1/2" stud kit.	#018685 \$674.95	#018685NS \$529.95
Ford 8.8" 1979-'93	Strange Pro-Race 33 spline axles, light weight spool, C-clip eliminator kit and 1/2" stud kit.	#018686 Call	#018686NS Call
Dana 60	Strange Pro-Race 33 or 35 spline axles, light weight spool, axle bearings with retainer plates and 1/2" stud kit.	#018688 \$784.95	#018688NS \$539.95
Olds or Lamb	Strange Pro-Race 33 or 35 spline axles, light weight spool, axle bearings and 1/2" stud kit	#018689 \$674.95	#018689NS \$529.95
Ford 9" Large Bearing, Olds or Lamb	Strange Pro-Race 40 spline axles - gun drilled, light weight spool, axle bearings and 5/8" stud kit.	#018687 \$974.95	#018687NS \$734.95

MARK WILLIAMS BILLET 4340 PINION YOKES

Ford 8.8" 30-spline, 1350 joint, 4340 alloy steel	#017151 \$195.00
Ford 9" 28-spline, standard pinion, 4340 alloy steel, 1350 joint	#010916 \$195.00
Ford 9" 35-spline, for 3:20 to 4:86 large pinion gear, 1350 joint, 4340 alloy steel	#010917 \$210.00

Shim, Ford 9" For use with stock Ford pinion housing	#015015 \$13.50
Dana 60 29-spline for 1350 series joint, 4340 alloy steel	#010919 \$195.00
12-Bolt Chevrolet 1350 joint, 4340 alloy steel	#010921 \$204.00

#019580



#018172



U-JOINTS & U-JOINT BOLTS

U-Joint 1350 Series Sportsman	#018172 \$34.95
U-Joint 1350 Series Pro	#010997 \$39.95
U-Joint Bolt kit 1350 Sportsman	#010993 \$19.00
U-Joint Bolt kit 1350 Pro Mark Williams	#019580 \$97.00
U-Joint Bolt kit 1350 Pro Strange	#017487 \$95.95

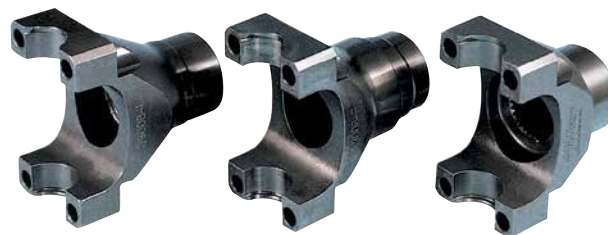

STANDARD PINION YOKES

Dana 60 (1350) heavy duty	#010970 \$99.95
12-bolt Chevy (1350) heavy duty	#010971 \$99.95
8.8" Ford 30-spline pinion (1350) chromoly	#017622 \$149.95
9" Ford 28-spline pinion (1350) chromoly	#010972 \$144.95
Pinion yoke spacer Standard (necessary if using stock pinion support)	#015015 \$13.50
9" Ford 35-spline pinion (1350) chromoly	#010973 \$144.95



MONDAY - FRIDAY 8AM - 5PM EST
SALES: 1.800.571.3023 TECH: 727.571.3023

SHOCKS, SPRINGS & COMPONENTS

HYPERCOIL/QA1 SPRINGS

Coilover springs are polyplastic coated to protect them from rust and corrosion.

NOTE: Springs are 2 1/2" ID and are ink-stamped with rate and height.

Springs are not returnable due to damage incurred during installation.

7" & 8"	Priced	12"	Priced Each
7-250	#008900 \$72.95	12-80	#008918 \$72.95
7-300	#008901 \$72.95	12-95	#008919 \$72.95
7-350	#008902 \$72.95	12-110	#008920 \$72.95
7-400	#008903 \$72.95	12-130	#008921 \$72.95
7-550	#008905 \$72.95	12-150	#008922 \$72.95
		12-170	#008923 \$72.95
		12-200	#008924 \$72.95

14"	Priced Each
14-80	#008934 \$72.95
14-95	#008935 \$72.95
14-110	#008936 \$72.95
14-130	#008937 \$72.95
14-150	#008938 \$72.95
14-175	#018498 \$72.95



RECOMMENDED SPRING RATES

7" & 8" SPRINGS

Spring Rate	Total Weight On Front Wheels
250	800 - 1000 lbs.
300	1000 - 1200 lbs.
350	1200 - 1500 lbs.
400	1500 - 1800 lbs.
550	2300 - 2500 lbs.

12" SPRINGS

Spring Rate	Total Weight On Rear Wheels
80	800 - 1000 lbs.
95	1000 - 1100 lbs.
110	1100 - 1200 lbs.
130	1200 - 1300 lbs.
150	1300 - 1400 lbs.
170	1400 - 1500 lbs.
200	1600 - 1800 lbs.

We also offer a full line of QA1, Hypercoil and Eibach springs.

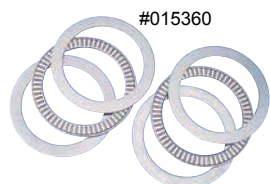

ART COILOVER SPRING SEAT WASHERS WITH TORRINGTON BEARINGS

This assembly is placed between the lower spring seat and the bottom of the spring and enables a smoother and more accurate spring adjustment.

#015360 \$37.95 (pair)



ART SPORTSMAN SPANNER WRENCH

#006268 \$16.95



PRO SPANNER WRENCH

#017477 \$39.95



#019488

AFCO DOUBLE ADJUSTABLE SHOCK

Aluminum body, independently double adjustable with 8 compression adjustment settings and 12 extension adjustment settings, includes hardware kit.

Extended Height Recommended Ride Height Compressed Height

16-7/8" 13-3/4" - 14-3/4" 12"

ELIMINATOR #019479 \$469.95
BIG GUN #010478 \$508.95
BIG GUN X #010476 \$508.95

20-7/8" 15-1/2" - 18-1/2" 14"

ELIMINATOR #019488 \$469.95
BIG GUN #010479 \$508.95
BIG GUN X #010477 \$508.95

**Special A.R.T. package price:
2 Eliminator shocks with
hardware & springs \$1034.95**

PROMASTAR SINGLE ADJUSTABLE SHOCK

Aluminum body, 18 adjustment settings.

**Special A.R.T. package price:
2 shocks with springs
\$559.95**



#008985

Extended Height	Recommended Ride Height	Compressed Height	
11 1/8"	9 1/2" - 10"	8 3/4"	#008982 \$219.95
16 7/8"	14" - 15"	11 5/8"	#008985 \$219.95
18 3/4"	15 1/4" - 16 3/4"	12 5/8"	#008987 \$219.95

PROMASTAR DOUBLE ADJUSTABLE SHOCK

Aluminum body, externally adjustable for both compression and rebound.

**Special A.R.T. package price:
2 shocks with springs
\$749.95**



#019905

Extended Height	Recommended Ride Height	Compressed Height	
11 1/8"	9 1/2" - 10"	8 3/4"	#019904 \$319.95
16 7/8"	14" - 15"	11 5/8"	#019905 \$319.95
18 3/4"	15 1/4" - 16 3/4"	12 5/8"	#019906 \$319.95



SHOCKS & COMPONENTS



STRANGE SINGLE ADJUSTABLE SHOCK

Aluminum body, 10 adjustment settings.

Extended Height	Recommended Ride Height	Compressed Height
11 ³ / ₈ "	10" - 10 ³ / ₈ "	8 ³ / ₄ "
#019907	\$194.95	
17 ¹ / ₈ "	13 ⁷ / ₈ " - 14 ¹ / ₂ "	11 ⁵ / ₈ "
#018994	\$194.95	
19 ¹ / ₈ "	15 ¹ / ₄ " - 16"	12 ⁵ / ₈ "
#018608	\$194.95	

**Special A.R.T. package price:
2 shocks with springs \$509.95**



STRANGE DOUBLE ADJUSTABLE SHOCK

Externally adjustable for both compression and extension.

Extended Height	Recommended Ride Height	Compressed Height
11 ³ / ₈ "	10" - 10 ³ / ₈ "	8 ³ / ₄ "
#019908	\$324.95	
17 ¹ / ₈ "	13 ⁷ / ₈ " - 14 ¹ / ₂ "	11 ¹¹ / ₁₆ "
#019921	\$324.95	
19 ¹ / ₈ "	15 ¹ / ₄ " - 16"	12 ¹¹ / ₁₆ "
#019262	\$324.95	

**Special A.R.T. package price:
2 shocks with springs
& Torrington bearings \$695.95**

#019262



#017480



ART SHOCK, SPRING, & MOUNT PACKAGE

Package includes: Mild steel upper shock mount kit, Adjustable lower shock mount, (2) Strange Engineering Single Adjustable Shocks and (2) 12" Coil springs of your choice.

#017480 \$629.95

SHOCK SET-UP JIG

Allows the chassis ride height to be set during chassis construction, adjustable from 13-1/2" - 16-1/2".

#019603 \$74.95 (pair).



#019603

MOUNTING KITS

ART ADJUSTABLE FRONT COILOVER MOUNT KIT

Allows up to 7" of front end height adjustment, features stepped bracket design, enables use of 1" high angularity shock bearings.

#009010 \$84.95



#009010

ART REAR UPPER SHOCK MOUNTING KITS

Weld-in kits include 40" crossmember, 4 brackets (double shear), spacers, bolts and nuts.

Sportsman mild steel kit #009020 \$55.95

Pro chromoly kit #018933 \$74.95

#009020



ART SHOCK SPUD KIT

Chromoly spud with 1/2 x 20 thread, integral .250 misalignment, .875 x 1.500 overall length, includes grade 8 hardware (pair).

#019778 \$30.95



#019778

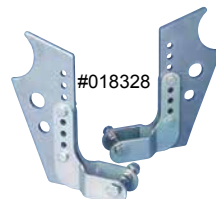

#018328

ART ADJUSTABLE LOWER SHOCK MOUNTING KITS

Up to 7" ride height adjustment (pair).

Housing Mounting Kit #018328 \$69.95

Rear Brace Mount Kit #019655 \$79.95

ART BILLET LOWER SHOCK MOUNTS

CNC-milled from billet aluminum, these mounts will work in conjunction with A.R.T. ladder bar or four-link brackets. Includes grade 8 hardware (pair).

Mounts Only #019387 \$124.95

Mount Package #017401 \$164.95

#019387



ART EXTREME LOWER SHOCK MOUNT KIT

CNC-milled from billet aluminum, with a black anodized finish. These mounts will work in conjunction with A.R.T. ladder bar or four-link brackets.

Includes NAS hardware (pair).

#017559 \$189.95

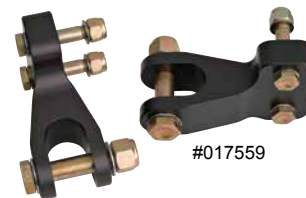

#017559

ART OFFSET BILLET LOWER SHOCK MOUNTS

CNC-milled from billet aluminum, with an 1-1/2" offset and a black anodized finish. These mounts will work in conjunction with A.R.T. ladder bar or four-link brackets.

Includes grade 8 hardware (pair).

#017490 \$139.95

#017490



WILWOOD ENGINEERING DISC BRAKES



Front

FRONT BRAKE KITS

Includes aluminum alloy hubs w/bearings, seals & studs, drilled rotors w/pads, mounting brackets, hardware & instructions.

Medium Duty 4 Piston Caliper with drilled rotors

Camaro '67-'69 / Nova '67-'74	#019091	\$857.50
Pinto / Mustang II '71-'78	#019092	\$857.50
Mustang '87-'93	#019093	\$857.50

Wilwood Pro Street Brakes available - Call for pricing.



Rear

REAR BRAKE KITS

Includes anodized aluminum 4-piston calipers, hats, mounting brackets & hardware and drilled rotors with pads and instructions.

Small Ford	#019186	\$677.50	Dana	#019095	\$677.50
Big Ford	#019094	\$677.50	Chevy 12 Bolt	#019187	\$677.50
Olds / Pontiac	#019096	\$677.50	Big Ford / New Style	#019657	\$677.50

STRANGE ENGINEERING DISC BRAKES

FRONT BRAKE KITS - STRANGE STRUTS

LIGHTWEIGHT - Includes single piston billet calipers & mounts, slider assembly, pads and forged slotted rotors. Does not include wheel hubs, bearings, races or seals.

Spindle mount kit for '87 & later Strange strut spindles w/Aluma Star 2.0 or Magnum wheels
#019511 **\$574.95**

MEDIUM DUTY - Includes forged slotted rotors, hubs with bearings, seals and studs, billet 2-piston calipers, organic pads, billet mounts and hardware.

5 x 4-1/2" - Bolt Circle	#018980	\$724.95
5 x 4-3/4" - Bolt Circle	#015610	\$724.95

HEAVY DUTY - Includes forged slotted rotors, hubs with bearings, seals and studs, billet 4-piston calipers, organic pads, billet mounts and hardware.

5 x 4-1/2" - Bolt Circle	#018920	\$924.95
5 x 4-3/4" - Bolt Circle	#018451	\$924.95

Strange Pro Race Steel Front Brake Kits Available for a wide variety of OEM Spindles Call for pricing



Front



Rear

STRANGE EVOLUTION BRAKE KITS

Evolution Brake kits feature high heat and corrosion resistant stainless steel lightweight scalloped Dynamic Drive Mount (DDM) rotors and billet aluminum hats secured by an internal Spirolox for reducing rotating weight and allowing for thermal expansion. This will drastically reduce warping, coning, and cracking. These kits also feature four piston Billet Evolution 4 Calipers optimized and field-tested to improve piston retraction, pedal feel, and stiffness resulting in improved pad wear and exemplary braking efficiency.

'57-'64 Olds	#018456LW	\$1094.95
Mopar/Dana		
<i>includes 2 A-1022 bearings</i>	#018457LW	\$1144.95
Big Bearing Ford (Early)	#018458LW	\$1094.95
Big Bearing Ford (Late)	#017395LW	\$1094.95
Lamb/Symmetrical	#018459LW	\$1094.95
Small GM	#018461LW	\$1144.95



Rear

REAR BRAKE KITS

Includes forged slotted rotors, forged 4-piston calipers, organic pads, billet mounts and hardware.

'57-'64 Olds	#018456	\$774.95
Mopar/Dana		
<i>includes 2 A-1022 bearings</i>	#018457	\$824.95
Big Bearing Ford (Early)	#018458	\$774.95
Big Bearing Ford (Late)	#017395	\$774.95
Lamb/Symmetrical	#018459	\$774.95
Small Ford/Mustang	#018460	\$774.95
Small GM	#018461	\$824.95



BRAKE COMPONENTS

WILWOOD REBUILD PARTS

- Rear Rotor, drilled (each)
#019624 \$114.95
- Brake Hat, 1/2" stud, Big Ford/Dana (each)
#019292 \$100.95
- Brake Hat, 1/2" stud, New Big Ford (each)
#018601 \$100.95
- Rotor to Hat Bolt Kit, (set of 8)
#019089 \$12.75
- 4-Piston Caliper, drag (each)
#019090 \$173.50
- O-ring Kit, 1.75 square seal (4-pack)
#019114 \$10.50

STRANGE REBUILD PARTS

- Rear Rotor,
slotted, left (each) #019591 \$174.95
- Rear Rotor,
slotted, right (each) #019590 \$174.95
- 4-Piston Caliper,
drag, left (each) #017123 \$169.95
- 4-Piston Caliper,
drag, right (each) #017122 \$169.95
- O-ring Kit,
4-piston, '96-present #017124 \$8.95

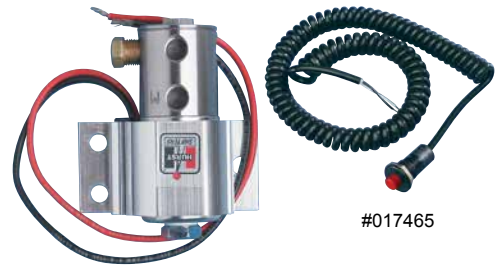

#017465

ART LINE LOCK & BUTTON PACKAGE

Hurst roll-control with button & cord.
#017465 \$209.95

BRAKE PADS

- | | Per Pad |
|--|-----------------|
| Airheart & Wilwood single piston caliper | #015551 \$10.95 |
| JFZ & Wilwood 2 piston caliper - organic | #015550 \$19.95 |
| JFZ & Wilwood 4 piston caliper - organic | #015562 \$13.95 |
| JFZ & Wilwood 4 piston caliper (Poly Matrix) | #018663 \$24.95 |
| JFZ & Wilwood 4 piston caliper - metallic | #015563 \$24.95 |
| Strange 1 or 2 piston caliper - organic | #017024 \$14.95 |
| Strange 4 piston caliper - organic | #015560 \$24.95 |
| Strange 4 piston caliper - metallic | #015561 \$24.95 |
| Lamb strut with 625 (Set of 4) | #018110 \$49.95 |



#015560

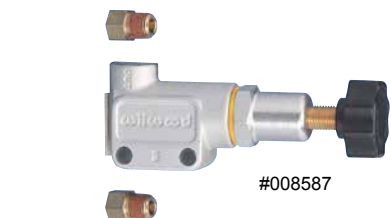

#008587

ADJUSTABLE PROPORTIONING VALVE

Brake proportioning valve with knob style adjustability allows for quick brake bias adjustments. 1/8" npt inlet and outlet.
#008587 \$48.50



#019467

PRO LINE LOCK

Hurst roll-control, with rebuildable stainless steel solenoid. Standard issue for most pro cars.
#019467 \$168.95



#008589



#008588

RESIDUAL PRESSURE VALVES

2-lb. Inline RPV #008588 \$20.75
10-lb. Inline RPV #008589 \$20.75



019682

PRO MASTER CYLINDER MOUNT KIT

Designed to mount master cylinder on a round tube chassis. Chromoly construction and includes gussets, adjustable rear support and NAS hardware
#019682 \$48.95



#018494

ART PUSH ROD KIT WITH SAFETY TAB

This kit retains the push rod within the master cylinder, preventing loss of brakes.
#018494 \$24.95



#019889

ART MASTER CYLINDER COVER

Composite #019889 \$54.95
Carbon Fiber #019514 \$178.95



019613

STAINLESS BANJO ASSEMBLY

1/2" x 20 #019613 \$34.95



MASTER CYLINDERS & ACCESSORIES

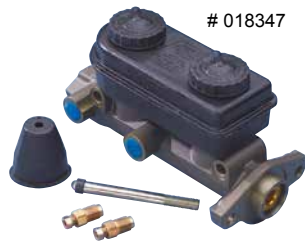

018347

PRO DUAL RESERVOIR MASTER CYLINDERS

Strange 1¹/₃₂" bore, includes push rod, boot & fittings #018347 \$88.95

Strange 1¹/₈" bore, includes push rod, boot & fittings #008520 \$88.95



#019043

HI-TEMP BRAKE FLUID

12 oz. 570 racing brake fluid is compatible with DOT 3, DOT 4 and DOT 5.1 fluids.

#019043 \$10.25

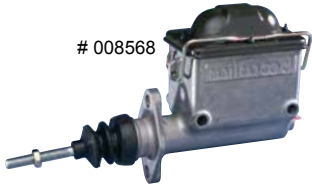

008568

SINGLE RESERVOIR MASTER CYLINDERS

3/4" bore #008564 \$69.95

7/8" bore #008568 \$69.95

1" bore #008572 \$69.95



019708

PRO STREET TANDEM MASTER CYLINDER

Designed for manually activated Pro Street brake applications. Features 1" bore with slotted mounting flange and fluid outlet on both sides of piston bore to simplify plumbing.

#019708 \$230.95

BRAKE LINE HOSE & FITTINGS

STEEL HOSE ENDS & FITTINGS FOR TEFLON-LINED

STEEL BRAIDED HOSE - #3 AN (Fitting also available in #4)

Type	Description		
Straight	hose end	#007036	\$7.95
45 degree	hose end	#007037	\$13.80
90 degree	hose end	#007038	\$14.05
1/8" NPT to #3 AN	male pipe-male flare	#007039	\$2.95
1/8" NPT to 90° #3 AN	male pipe-male flare	#007040	\$7.20
Bulkhead tee	#3 AN male	#015486	\$29.85
Bulkhead tee on-the-run	#3 AN male	#016105	\$19.95
Bulkhead 90-degree	#3 AN male	#015484	\$11.50
Bulkhead straight	#3 AN male	#015482	\$5.90
Bulkhead nuts	#3 AN	#007047	\$1.95

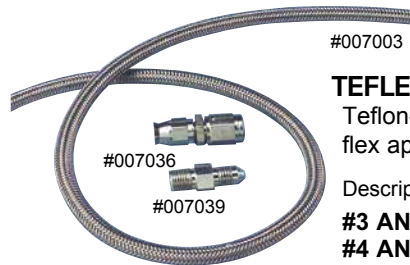

#007003

TEFLEX BRAKE HOSE - 3000 psi

Teflon-lined hose for short distance, flex applications.

Description	Price Per Foot
#3 AN #007000	\$4.10
#4 AN #007003	\$4.90

STEEL TUBE NUTS & SLEEVES

Steel tube nuts and sleeves are normally used to connect steel brake line (hard line) to AN fittings.

Nut, #3	#007024	\$1.60
Nut, #4	#007026	\$1.60
Sleeve, #3	#007025	\$1.20
Sleeve, #4	#007027	\$1.20

HARD STEEL BRAKE LINE

Easily formed, 25-foot length. 3/16" O.D. #007007 \$39.95



#007007

STAINLESS STEEL BRAKE LINE

Easily formed, 20-foot length. 3/16" O.D. #017466 \$84.95

PRE-ASSEMBLED BRAKE LINES

#3 90/straight, 18" long	#018794	\$15.95
#3 straight/straight, 18" long	#018795	\$13.25



#018794

#018795

COMPLETE PRO BRAKE LINE KIT

Includes AN fittings, #3 teflon lined stainless hose, steel brake line and tabs, line lock fittings, complete kit necessary for installation of after-market disc brakes.

#018200 \$219.95

Above kit with 18" Teflon lines and fittings assembled.

#018796 \$229.95



#018200

Upgrade to Stainless Steel Brake Line add \$45.00

BRAID SPREADER

Simplifies installing the olive in #3 and #4 Teflon-lined hose. The tool is pushed into the cut end of the hose, spreading the braid, and the mandrel inserts the olive under the braid and over the hose liner.

#019553 \$44.95



#019553

HEADER KITS & COMPONENTS

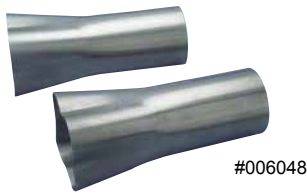

#006048

WELD-ON COLLECTORS

Tube	Collector	Pair	
1 7/8"	3 1/2" x 10"	#006044	\$89.95
2"	3 1/2" x 10"	#006045	\$89.95
2 1/8"	3 1/2" x 10"	#006046	\$89.95
2 1/4"	4" x 10"	#006048	\$89.95
2 3/8"	4 1/2" x 10"	#018880	\$56.95
2 1/2"	4 1/2" x 10"	#017175	\$63.95



#006063

DYNATECH SLIP-ON COLLECTORS

Includes tabs

Tube	Collector	Pair	
2"	3 1/2" x 12"	#006060	\$239.95
2 1/8"	3 1/2" x 12"	#006061	\$239.95
2 1/4"	4" x 12"	#006063	\$239.95
2 3/8"	4 1/2" x 12"	#006064	\$239.95
2 1/2"	4 1/2" x 12"	#019698	\$239.95
2 1/2"	5" x 12"	#017430	\$239.95



#018984

COLLECTOR TAB KIT

Mild steel, set of 8

#018984 \$15.95



#017553

HEADER GASKET

2-1/4" BBC (Pair)	#017553	\$34.95
2-3/8" BBC (Pair)	#017554	\$29.95



#019296

HEADER BOLTS

Hex head, black oxide
3/8"-16 x 1" #019296 \$1.75 each

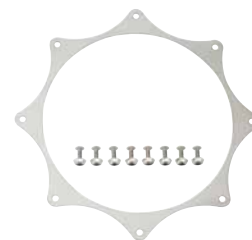

#017417

STAINLESS STEEL HEADER TRIM RINGS

Stainless steel rings are CNC laser cut and are 1/2" oversize per exhaust size. Includes stainless steel hardware.

4-1/2" ID	#017417	\$18.00
5" ID	#017418	\$18.00



#018570

HEDMAN WELD-UP KITS

2" SBC	#018572	\$379.95
2 1/8" BBC	#018569	\$284.95
2 1/4" BBC	#018570	\$295.95
2 1/4" BBC slip-on collectors	#019754	\$393.95
2 3/8" BBC	#018571	\$310.95
2 3/8" BBC slip-on collectors	#019755	\$404.95
2 1/2" BBC	#019893	\$326.95
2 1/2" BBC slip-on collectors	#019894	\$429.95

Other sizes and applications available, please call.

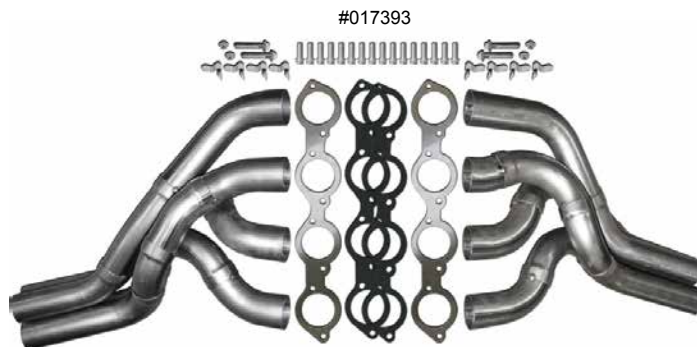

#017393

DYNATECH SIDE-EXIT WELD-UP KIT

2 1/4" - 2 3/8" BBC without collectors	#017393	\$599.95
2 3/8" - 2 1/2" BBC without collectors	#017394	\$599.95

Universal kit is not vehicle specific.



HEADER KITS & COMPONENTS



#006029

FLANGE KITS

5/16" thick, for BBC Standard Port.

BB Chev. round port 2 1/8" #006028 \$149.95

BB Chev. round port 2 1/4" #006029 \$149.95

BB Chev. round port 2 3/8" #006030 \$149.95

*Flange kits contain two flanges, bolts and gaskets.
Other flange kits with and without stubs available.*



#017508

304 STAINLESS FLANGES

3/8" thick, flange only, for BBC Standard Port.

2-1/4" #017507 \$89.95 each

2-3/8" #017508 \$89.95 each

2-1/2" #017509 \$89.95 each



#006074

J-BENDS

*All J-bends are 18-gauge and
180-degree mandrel bent.*

OD	RADIUS		
2"	#006074	3"	\$29.95
2 1/8"	#006075	4"	\$22.95
2 1/4"	#006076	3 1/2"	\$29.95
2 3/8"	#006077	3"	\$24.95
2 1/2"	#018182	4"	\$39.95

Different radius sizes available.



#017494

304 STAINLESS J-BENDS

*All J-bends are 18-gauge and
180-degree mandrel bent.*

OD	RADIUS		
1 7/8"	#017491	3"	\$39.95
2"	#017492	3"	\$44.95
2 1/8"	#017493	3"	\$59.95
2 1/4"	#017494	3 1/2"	\$44.95
2 3/8"	#017624	3"	\$72.95
2 1/2"	#017495	4"	\$74.95

HEADER WELDMENTS

EGT Weldment – Steel #017613 \$8.95
EGT Weldment – Stainless #017614 \$12.00

#017614



EGT Weld Bung Cap – Steel #017615 \$1.00

#017615



EGT Probe Ferrule #017616 \$4.95

#017616



Weld Bung 1/8" NPT #017621 \$6.00

#017621



EGT Probe Nut #017617 \$4.95

#017617



O2 Male Plug – Stainless #017620 \$8.00

#017620



O2 Weld Bung – Steel #017618 \$8.50

#017618



O2 Weld Bung – Stainless #017619 \$12.00

#017619



RADIATORS & ACCESSORIES



#018191

ALUMINUM PRO RADIATORS

- All aluminum construction, including tanks
- Available 1 1/4" I.D. hoses
- Tabs & stands for chassis & shroud mounting
- 2 rows 1" tubes
- Accepts Pro Fan & Shroud offered below

21 1/2" x 14" (including cap provision) #018189 \$429.95
 Radiator Cap for above, 22-24 lbs. #019003 \$16.50
 21 1/2" x 12 3/4" (without cap provision) #018191 \$429.95



#017565

ALUMINUM PRO PLUS RADIATORS

- Aluminum construction, including tanks
- Non epoxy, furnace brazed
- Includes two fittings, please specify when ordering:
- Two rows 1" tubes
- Accepts Pro Plus Fan & Shroud offered below

#20 to 1-1/4", 1-1/2" or 1-3/4" round hose, #20 to #12AN or #20 to #16AN
 22" x 15-1/4" (including cap provision) #017566 \$699.95
 Radiator Cap for above, 22-24 lbs. #019003 \$16.50
 22" x 14-1/2" (without cap provision) #017565 \$699.95



#017569

PRO PLUS HOSE FITTING ADAPTERS

#20 to 1-1/4" Hose #017580 \$24.95
 #20 to 1-1/2" Hose #017581 \$24.95
 #20 to 1-3/4" Hose #017582 \$24.95
 #20 to #12AN #017583 \$24.95
 #20 to #16AN #017584 \$24.95

DRAGSTER RADIATOR PACKAGE

- Aluminum construction
- Non epoxy, furnace brazed
- Fan & shroud
- 20-1/2" x 17-1/2", 3/4" NPT inlet & outlet

#017569 \$799.95

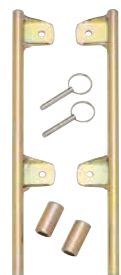

#018208

SPORTSMAN RADIATOR MOUNT KIT
 Features removable design, DOM tubing and mild steel brackets
 #018208 \$39.95



#017120

WATER WETTER
 #017120 \$13.95

PRO RADIATOR MOUNT KIT

Features removable design, all chromoly tubing and brackets.
TIG welding required.
 #019346 \$64.95



FAN & SHROUD ASSEMBLIES



#019363

SLIMLINE FAN
 12" fan only, 1050 CFM.
 #019363 \$120.95



#019382

FAN & SHROUD PACKAGES

Includes aluminum shroud with fan.
Pro Fan & Shroud #019382 \$214.95
Pro Plus Fan & Shroud #017568 \$249.95



#017568



MONDAY - FRIDAY 8AM - 5PM EST
 SALES: 1.800.571.3023 TECH: 727.571.3023

RADIATORS & ACCESSORIES



#018949

ART PRO RADIATOR KIT

Includes Pro Aluminum Radiator (with/without cap provision), and Slimline fan with aluminum shroud.

#018949 \$614.95



#017567

ART PRO PLUS RADIATOR KIT

- Includes aluminum Pro Plus Radiator (with/without cap provision)
- Two rows 1" tubes • Non epoxy, furnace brazed
- Pro Plus Fan & Shroud • Includes two fittings, **please specify when ordering: #20 to 1-1/4", 1-1/2" or 1-3/4" round hose, #20 to #12AN or #20 to #16AN**

#017567 \$854.95



#019483

MEZIERE MINI INLINE REMOTE WATER PUMP

#12 O-ring inlet and outlet, flows 20 GPM. Well suited for Alcohol powered cars.

Fittings not included.

#019483 \$249.95



#019452

MEZIERE BULKHEAD REMOTE WATER PUMP

1" NPT inlet, two #12 O-ring outlets (no water manifold required), flows 35 GPM. Fittings not included.

#019452 \$364.95



#018889

MEZIERE BILLET ALUMINUM WATER PUMPS

35 gallon per minute flow rate, the choice of today's top engine builders!

SB Chevy #018890 \$399.95

BB Chevy #018889 \$409.95

Fittings For Above

1" pipe to 1 1/4" hose #018891 \$20.95

1" pipe to 1 1/2" hose #018945 \$20.95

1" pipe to 1 3/4" hose #018892 \$20.95



#019659

REMOTE WATER PUMP FITTINGS

#10 flare to #12 straight, hi-flow #019659 \$18.95

#12 flare to #12 straight, hi-flow #019658 \$18.95

OVERFLOW TANKS

1-quart capacity

Aluminum #019408 \$144.95

Plastic Black #015370 \$35.95



#019408



#015370

ART RADIATOR OVERFLOW KIT

Includes aluminum tank, mounting bracket, hardware, snap-lock fittings and 12" line.

#017121 \$169.95

#017121



#019406

OVERFLOW TANK MOUNTING BRACKET

Mounts overflow tank to the side of Sirocco-style radiators.

#019406 \$8.95

SALES@APPLIEDRACING.COM

ORDER ONLINE @ WWW.APPLIEDRACING.COM



AN FITTINGS

REDHORSE AN FITTINGS

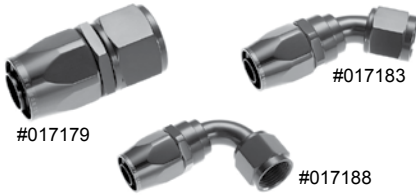

SWIVEL HOSE ENDS

Size	Type	Part #	Price
#4	straight	#017364	\$8.55
#6	straight	#017176	\$6.20
#6	45 degree	#017181	\$14.10
#6	90 degree	#017186	\$12.60
#8	straight	#017177	\$7.25
#8	45 degree	#017182	\$15.20
#8	90 degree	#017187	\$14.40
#10	straight	#017178	\$9.85
#10	45 degree	#017183	\$18.50
#10	90 degree	#017188	\$16.15
#12	straight	#017179	\$11.35
#12	45 degree	#017184	\$20.65
#12	90 degree	#017189	\$18.00
#16	straight	#017180	\$18.20
#16	45 degree	#017185	\$41.65
#16	90 degree	#017190	\$34.20



TEE'S - AN MALE

#3	#017223	\$10.45
#4	#017224	\$10.45
#6	#017225	\$10.45
#8	#017226	\$13.95
#10	#017227	\$19.75



BLACK NYLON BRAIDED HOSE

Supplied by the foot.

#4	#017289	\$4.20
#6	#017290	\$5.15
#8	#017291	\$6.30
#10	#017292	\$7.50
#12	#017293	\$9.40
#16	#017533	\$13.95

E85 BLACK NYLON BRAIDED HOSE

Supplied by the foot.

#4	#008504	\$5.95
#6	#008506	\$7.25
#8	#008508	\$8.50
#10	#008510	\$9.25
#12	#008512	\$11.95

Note: Cut-to-length AN hose is not returnable

#017239



MALE FLARE UNIONS

#4	#017237	\$4.30
#6	#017238	\$4.30
#8	#017239	\$5.80
#10	#017240	\$5.80
#12	#017241	\$12.80

#017273



AN FLARE CAPS AND PLUGS

	Caps	Plugs
#3	#017270 \$2.75	#017264 \$1.45
#4	#017271 \$3.50	#017265 \$1.45
#6	#017272 \$2.90	#017266 \$1.60
#8	#017273 \$6.60	#017267 \$4.30
#10	#017274 \$8.15	#017268 \$5.45
#12	#017275 \$10.45	#017269 \$7.00

#017267



ALUMINUM PIPE TO FLARE (NPT TO AN) ADAPTERS

NPT to AN	Type	Part #	Price
1/8" to #3	straight	#017191	\$3.50
	90 degree	#017205	\$8.15
1/8" to #4	straight	#017192	\$3.50
	90 degree	#017206	\$8.15
1/4" to #4	straight	#017193	\$3.50
	90 degree	#017207	\$8.70
1/8" to #6	straight	#017194	\$2.90
	90 degree	#017208	\$8.15
1/4" to #6	straight	#017195	\$2.90
	90 degree	#017209	\$9.90
3/8" to #6	straight	#017196	\$3.50
	90 degree	#017210	\$11.65
1/4" to #8	straight	#017197	\$5.45
	90 degree	#017211	\$15.10
3/8" to #8	straight	#017198	\$3.50
	90 degree	#017212	\$10.45
1/2" to #8	straight	#017199	\$4.65
	90 degree	#017213	\$17.45
3/8" to #10	straight	#017200	\$5.80
	90 degree	#017214	\$15.10
1/2" to #10	straight	#017201	\$4.65
	90 degree	#017215	\$17.45
1/2" to #12	straight	#017202	\$9.30
	90 degree	#017216	\$19.75
3/4" to #12	straight	#017203	\$9.30
	90 degree	#017217	\$19.75
3/4" to #16	straight	#017204	\$19.75



HI-FLOW AN FITTINGS

O-rings sold separately and are not included.

#6 male to #6 o-ring	#017307	\$9.30
#6 male to #8 o-ring	#017308	\$10.45
#10 male to #10 o-ring	#017309	\$13.95
#10 male to #12 o-ring	#017310	\$17.45
#12 male to #10 o-ring	#017311	\$20.95



BULKHEAD UNIONS - STRAIGHT

#3	#017244	\$4.65
#4	#017245	\$5.45
#6	#017246	\$8.15
#8	#017247	\$9.30
#10	#017248	\$13.95
#12	#017249	\$17.45

Note: 90 degree bulkhead unions also available

BULKHEAD NUTS

#3	#017276	\$1.85
#4	#017277	\$2.10
#6	#017278	\$2.65
#8	#017279	\$3.80
#10	#017280	\$4.40
#12	#017281	\$4.90

#017279

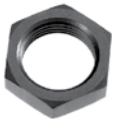

FEMALE SWIVEL COUPLERS

#4	#017234	\$9.30
#6	#017235	\$9.30
#8	#017236	\$10.45

PIPE PLUGS

NPT Size	Part #	Price
1/8"	#017259	\$2.30
1/4"	#017260	\$2.20
3/8"	#017261	\$2.45
1/2"	#017262	\$5.45
3/4"	#017263	\$8.15

#017262



ADJUSTABLE AN WRENCH

Adjusts from 3AN to 16AN.
#017474 \$49.95



Complete line of Redhorse AN fittings available.

MONDAY - FRIDAY 8AM - 5PM EST

SALES: 1.800.571.3023 TECH: 727.571.3023

XRP AN FITTINGS



DOUBLE SWIVEL HOSE ENDS

Size	Type	Part #	Price
#4	straight	#007111	\$9.10
#4	45 degree	#007122	\$21.30
#4	90 degree	#007133	\$21.70
#6	straight	#007112	\$9.70
#6	45 degree	#015460	\$26.05
#6	90 degree	#015416	\$25.50
#8	straight	#007113	\$12.20
#8	45 degree	#015461	\$30.50
#8	90 degree	#015417	\$31.40
#10	straight	#007114	\$15.95
#10	45 degree	#015462	\$35.55
#10	90 degree	#015418	\$35.55
#12	straight	#007115	\$21.80
#12	45 degree	#015463	\$42.55
#12	90 degree	#015419	\$42.60
#16	straight	#018757	\$34.95
#16	45 degree	#018758	\$55.65
#16	90 degree	#018759	\$55.65

NOTE: Many 120 and 180 degree hose ends in stock.



ALUMINUM PIPE TO FLARE (NPT to AN) ADAPTERS

NPT to AN	Type	Part #	Price
1/8" to #3	straight	#007230	\$2.90
	90 degree	#007231	\$9.25
1/8" to #4	straight	#007234	\$2.90
	90 degree	#007235	\$9.40
1/4" to #4	straight	#007237	\$3.35
	90 degree	#007238	\$9.45
1/8" to #6	straight	#007240	\$3.85
	90 degree	#007241	\$11.35
1/4" to #6	straight	#007243	\$3.10
	90 degree	#007244	\$9.65
3/8" to #6	straight	#007246	\$4.05
	90 degree	#007247	\$12.95
1/4" to #8	straight	#007249	\$4.20
	90 degree	#007250	\$16.20
3/8" to #8	straight	#007252	\$4.20
	90 degree	#007253	\$11.70
1/2" to #8	straight	#007255	\$6.10
	90 degree	#007256	\$18.60
3/8" to #10	straight	#007258	\$6.95
	90 degree	#007259	\$20.25
1/2" to #10	straight	#007261	\$6.20
	90 degree	#007262	\$18.45
1/2" to #12	straight	#007264	\$11.60
	90 degree	#007265	\$27.00
3/4" to #12	straight	#007267	\$11.35
	90 degree	#007268	\$27.00
3/4" to #16	straight	#007270	\$22.70

FEMALE SWIVEL COUPLERS

#4	#016076	\$8.25
#6	#016077	\$8.40
#8	#016078	\$10.15
#10	#016079	\$12.30
#12	#016080	\$17.25

NOTE: Also available in 45 and 90 degree.

ALUMINUM TUBE NUTS AND SLEEVES

#4 sleeve	#007160	\$1.20
#4 nut	#007161	\$1.20
#6 sleeve	#007170	\$1.55
#6 nut	#007171	\$1.55
#8 sleeve	#007180	\$1.75
#8 nut	#007181	\$2.20
#10 sleeve	#007182	\$2.60
#10 nut	#007183	\$3.10



NPT (PIPE) REDUCER BUSHINGS (ALUM.)

NPT Size	Part #	Price
1/4" to 1/8"	#007280	\$4.20
3/8" to 1/8"	#007281	\$4.55
3/8" to 1/4"	#007282	\$4.55
1/2" to 1/8"	#007283	\$6.10
1/2" to 1/4"	#007284	\$6.10
1/2" to 3/8"	#007285	\$5.25
3/4" to 1/4"	#007286	\$12.10
3/4" to 3/8"	#007287	\$10.25
3/4" to 1/2"	#007288	\$10.25
1" to 3/8"	#007289	\$15.50
1" to 1/2"	#007290	\$15.50
1" to 3/4"	#007291	\$15.50



STEEL BRAIDED HOSE

The highest quality. Supplied by the foot. Other sizes available.

#4	#007204	\$8.05
#6	#007206	\$7.75
#8	#007208	\$8.95
#10	#007210	\$12.40
#12	#007212	\$14.00
#16	#018749	\$17.65

NOTE: Cut-to-length AN hose is not returnable.

MALE FLARE UNIONS

#4	#007341	\$3.45
#6	#007342	\$3.45
#8	#007343	\$6.15
#10	#007344	\$7.00
#12	#007345	\$13.50

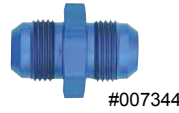

MALE AN WELD BUNGS

#4	#016170	\$4.70
#6	#016171	\$4.80
#8	#015380	\$6.35
#10	#015381	\$7.45
#12	#015382	\$12.65
#16	#015383	\$17.05

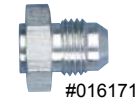

FEMALE NPT WELD BUNGS

1/8"	#015385	\$4.45
1/4"	#015386	\$4.95
3/8"	#015387	\$6.20
1/2"	#015388	\$7.30
3/4"	#015389	\$10.45



AN FLARE CAPS AND PLUGS

Size	Part #	Price	Part #	Price
#3	#007433	\$2.35	#007432	\$1.80
#4	#007434	\$2.75	#007435	\$1.80
#6	#007436	\$4.45	#007437	\$1.80
#8	#007438	\$5.25	#007439	\$3.35
#10	#007440	\$6.40	#007441	\$4.30
#12	#007442	\$8.45	#007443	\$6.25



HOLLEY BOWL FITTINGS

#6 AN	#007388	\$9.25
#8 AN	#007390	\$9.25

WISE JAW INSERTS (PAIR)

#019304 \$21.15

PIPE COUPLERS - FEMALE

NPT Size	Part #	Price
1/8"	#007296	\$3.65
1/4"	#007297	\$4.20
3/8"	#007298	\$7.00
1/2"	#007299	\$11.35
3/4"	#007300	\$17.40



PIPE PLUGS

NPT Size	Part #	Price
1/8"	#007420	\$1.55
1/4"	#007422	\$1.55
3/8"	#007424	\$1.95
1/2"	#007426	\$4.15
3/4"	#007428	\$5.25



TEE'S - ALUMINUM

AN Male	Part #	Price
#3	#007356	\$10.25
#4	#007359	\$10.25
#6	#007362	\$10.25
#8	#007365	\$17.25
#10	#007368	\$22.20



BULKHEAD NUTS - ALUMINUM

#3	#007322	\$1.20
#4	#007323	\$1.20
#6	#007324	\$1.35
#8	#007325	\$2.55
#10	#007326	\$2.60
#12	#007327	\$2.95



PRO AN WRENCH SET

Double end, includes #3 to #20. #019013 \$112.95

PIPE NIPPLES - MALE

NPT Size	Part #	Price
1/8"	#007292	\$2.80
1/4"	#007293	\$4.20
3/8"	#007294	\$7.30
1/2"	#007295	\$9.40



BULKHEAD UNIONS STRAIGHT AND 90

#3	straight	#007301	\$5.05
	90 degree	#007302	\$10.80
#4	straight	#007304	\$4.55
	90 degree	#007305	\$7.60
#6	straight	#007307	\$5.15
	90 degree	#007308	\$10.25
#8	straight	#007310	\$8.50
	90 degree	#007311	\$15.50
#10	straight	#007314	\$12.50
	90 degree	#007315	\$20.45
#12	straight	#007317	\$15.65
	90 degree	#007318	\$29.15

NOTE: Other sizes, 45 degree and tees also available.



ADEIL CLAMPS

3/16" OD line	#018345	\$1.05
3/8" OD line	#018116	\$0.80
1/2" OD line	#018117	\$0.95

FUEL SYSTEMS & ACCESSORIES

MAGNA FUEL COMPONENTS

QUICK STAR 275 FUEL PUMP

Designed for up to 700 horsepower applications, external bypass is preset to 18 psi, 12 or 16 volt compatible, gasoline or alcohol compatible.

#019572 \$359.95



PRO STAR 500 FUEL PUMP

Designed for 700 - 2000 horsepower applications, externally adjustable bypass, 24 - 36 psi, 12 or 16 volt compatible, gasoline or alcohol compatible.

#019570 \$478.95

*These pumps require two #12 to #12 (#019658) or two #12 to #10 (#019659) fittings.



PRO STAR 625 EFI FUEL PUMP

Designed for 2000+ horsepower, 12 or 16-volt compatible, gas or alcohol compatible.

#017598 \$868.95



PRO STAR 500 FUEL PUMP WITH FILTER

Includes same features as standard 500 pump, plus integral micron filter, which can be removed for cleaning allowing repeated use.

#019571 \$638.95



AEROMOTIVE A3000 FUEL PUMP

#017389 \$939.95

2 PORT REGULATOR

Features #10 AN inlet port and two #6 AN outlet ports, with 1/8" NPT pressure port for gauge, gasoline or alcohol compatible.

#019574 \$154.95



2 PORT REGULATOR PLUMB KIT

Includes one #10 and two #6 high-flow AN fittings with o-rings.

#019825 \$34.95

4 PORT REGULATOR

Features #10 AN inlet port and four #6 AN outlet ports, with 1/8" NPT pressure port for gauge, gasoline or alcohol compatible.

#019573 \$239.95



4 PORT REGULATOR PLUMB KIT

Includes one #10 and four #6 high-flow AN fittings with o-rings.

#019826 \$53.95

INLINE FILTER

74-Micron pre-filter, 4-3/4" long, 2-1/8" diameter, #10 AN inlet and outlet ports, cleanable filter element, gasoline or alcohol compatible. *Fittings are not included.*

#017361 \$109.95



#019659

#019783



#019785

MAGNA FUEL FITTINGS

#12 AN to #10 straight Hi-Flo	#017366	\$18.95
#10 AN to #10 straight Hi-Flo	#017365	\$16.95
#12 AN to #12 straight Hi-Flo	#019658	\$18.95
#10 AN to #12 straight Hi-Flo	#019659	\$18.95
#10 straight port plug	#019783	\$9.95
#10 straight to #10 straight coupler	#019784	\$27.95
Triple fuel log	#019785	\$53.95

FUEL ACCESSORIES



#019712

RELAYS

Relay Only 50 amp #017332 \$13.95

Single Relay with Harness #006343 \$22.95

Dual Relay with Harness #019712 \$54.95

#019385

VIBRATION ISOLATOR

Helps prevent harmonics from compromising the optimum performance of your regulator.

8/32 #019610 \$4.25

1/4 - 20 #019611 \$4.25

#019611



#019525



#019528



FUEL PRESSURE GAUGES 1-5/8"

0 to 15psi Dry #019525 \$26.95

0 to 15psi Liquid filled #019526 \$50.95

0 to 30psi Dry #019527 \$26.95

0 to 30psi Liquid filled #019528 \$50.95

FUEL PRESSURE TAKE-OFF ADAPTERS

With 1/8" female NPT port

#6 male to #6 female swivel #018905 \$12.40

#8 male to #8 female swivel #018909 \$14.40



MONDAY - FRIDAY 8AM - 5PM EST

SALES: 1.800.571.3023 TECH: 727.571.3023

FUEL CELLS & ACCESSORIES

ACCESS DOOR KITS

Bolt-in, complete with template, aircraft-quality hardware.
Door measures 6" x 6", overall dimensions 8" x 8".

- Clear anodized** #015070 \$64.95
- Carbon** #019926 \$69.95
- Latch only** #018655 \$29.95

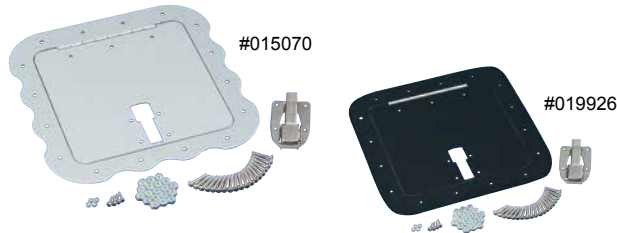

FUEL CELL ROLLOVER VALVE

Prevents fuel run-out through vent in case of rollover.

- For #6** #019366 \$37.95
- For #8** #017144 \$38.95

JAZ VERTICAL FUEL CELLS

- 1 Gallon** #019320 \$209.95
- 3 Gallon** #006925 \$214.95
- 4 Gallon** #006926 \$224.95
- 5 Gallon** #006807 \$215.95



FUEL CELL VENT KIT

- #019952** \$29.95
- Filter only** #019951 \$12.95



TWO GALLON PRO STOCK FUEL CELL

Carries SFI certification label.
#019683 \$599.95



FUEL CELL CAP ASSEMBLIES

Pro Werks Mount
2-1/4 x 10 thread,
6 on 4.438 bolt circle,
3/4" bung height, includes
mounting hardware.
#017371 \$94.95



TWO GALLON PRO STOCK FUEL CELL MOUNT

#019681 \$215.95

JAZ HORIZONTAL FUEL CELLS

Capacity	Size		
5 Gallon	13" x 13" x 8"	#006805	\$214.95
8 Gallon	20" x 15" x 7 1/2"	#006809	\$224.95
12 Gallon	17 1/2" x 16" x 10"	#006813	\$249.95
16 Gallon	25" x 17" x 9"	#006815	\$319.95



VP UTILITY JUGS 5.5-GALLON

- Clear** #018088 \$35.95
- Red** #018089 \$35.95
- Blue** #018090 \$35.95



DRAGSTER/ALTERED FUEL CELL 4-GALLON

Shaped with slope to fit tight quarters. 8 1/2" T x 12 1/2" W x 12" D.
#006930 \$234.95

We Offer The Complete Line of Jaz Products

SALES@APPLIEDRACING.COM
ORDER ONLINE @ WWW.APPLIEDRACING.COM



IGNITION & TRANSMISSION ACCESSORIES

#019519

TRANSMISSION FLUID

In-house testing has shown increased parts longevity and cooler fluid temperatures.
1 Gallon.

#019519 \$39.95



#019632

T.C.I. FLEXPATES

S.F.I. 29.1

BBC External #019631 \$121.95

BBC/ SBC Internal #019632 \$129.95



#019717

TRANSMISSION OVERFLOW TANK

1-pint capacity, 1/8" NPT top, 1/4" NPT bottom, 1/4 - 20 mounting bungs.

#019717 \$109.95



#017006

MSD 7 AL-3 DIGITAL BOX

#017006 \$984.95



#017511

POWERGLIDE FLEXIBLE LOCKING DIP STICK

Brite anodized 6061 aluminum, firewall mount and PTFE lined braided hose.

#017511 \$209.95

POWERGLIDE LOCKING DIP STICKS

Shorty #018833 \$49.95

Standard #019633 \$49.95



#018833



#017004

MSD PRO POWER COIL

#017004 \$184.95

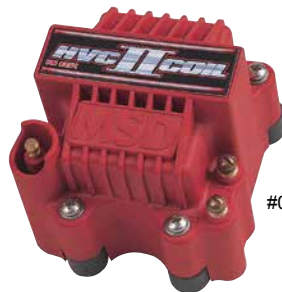

#017005

MSD HVC-2 COIL

#017005 \$325.95



#017003

MSD CRANK TRIGGER PICKUP

Non-magnetic.

#017003 \$119.95



#017386

MSD POWER GRID SYSTEM CONTROLLER

Available in red or black finish.

#017386 \$589.95



#017387

MSD POWER GRID IGNITION CONTROL BOX

#017387 \$659.95



#017002

MSD CRANK TRIGGER KIT

BB Chevy 8" balancer.

#017002 \$469.95

We Offer The Complete Line Of MSD Products.



RACEPAK COMPONENTS

RACEPAK SPORTSMAN DATA RECORDER

Includes

Data logger
User-terminated harness
SD card reader
Datalink II software disc
USB to Serial adapter
Serial cable

#017370 **\$1169.95**

Driveshaft collar must be purchased separately.

Internal Sensors

Engine RPM
Driveshaft RPM
Battery Voltage
2-Axis G-meter
12 volt event

Specifications

Lightweight composite housing
SD memory card
21 channels (6 user-defined)
100 samples per second (max rate)
6" x 4-1/2" x 1" (weighs .65 lbs)



#017586



RACEPAK DASH IQ3

Allows up to 28 inputs on four pages, LCD screen with blue backlight, programmable Shift and Warning lights.

#017586 **\$969.95**

RACEPAK OPTIONS

SINGLE EXHAUST GAS TEMPERATURE

RacePak #800-TC-S4-28MMC + 230-VM-TC-EGT + 800-TX-WASMA4
\$308.85 *(Other lengths available)*

PRESSURE CHANNEL / FUEL, OIL, N2O

Starting at **\$359.95** each

WIDE-OPEN THROTTLE CHANNEL

(without Bracket)

RacePak #220-VP-WOTEVENT
\$174.95

SHOCK TRAVEL SENSOR KIT - FRONT

(0-4" Door Car)

RacePak #280-KT-DSHKTRVF
\$1219.95 *(Other travel lengths available)*

SINGLE O2 SENSOR WITH MODULE

RacePak #220-VM-AF1
\$529.95

V-NET CABLES

Starting at **\$65.95** each

8 EXHAUST GAS TEMPERATURES STD BBC

RacePak #220-VP-TC-1357B18 + 220-VP-TC-2468B18
Starting at **\$1919.90** each
(Other engine applications available)

FLUID TEMPERATURE CHANNEL

Starting at **\$75.95** each

CLUTCH INPUT SHAFT RPM, ENGINE VS

CLUTCH SLIP RATIO

RacePak #220-VP-CL-1
\$369.95

SHOCK TRAVEL SENSOR KIT - REAR

(0-8" Door Car)

RacePak #280-KT-DSHKTRVR
\$1299.95 *(Other travel lengths available)*

O2 SENSOR

RacePak #810-SN-AFAMP
\$119.95

INTERFACE CABLES

Starting at **\$99.95** each

To ensure correct applications, pricing and availability. Please give us a call for any of your RacePak needs.

DATA RECORDER ACCESSORIES



#017608

SPLIT COLLAR 8-MAGNET RINGS

Small Strange 1.812 #017606 **\$119.95**
Small Mark Williams 1.875 #017607 **\$119.95**
Large Strange 2.125 #017608 **\$119.95**
Large Mark Williams 2.187 #017609 **\$119.95**



#017611

PROXIMITY SENSOR 5/16 - 24 3-PIN

#017611 **\$199.95**

PROXIMITY SENSOR L BRACKET

#017610 **\$29.95**

CO2 BOTTLES & ACCESSORIES



#018631

**SPORTSMAN
10 oz CYLINDER
WITH VALVE**
#018631 \$104.95



#019316

**SPORTSMAN
CYLINDER PACKAGE**
Includes polished 10 oz.
cylinder with valve, regulator
and bar mount clamp.
#019316 \$289.95



#018999

**BILLET CO²
CYLINDER KNOBS**
For 10 oz. and
2.5 lb. cylinders
with 5/16" valve provision.
#018999 \$24.95

*Plastic knobs cannot be
credited towards upgrade.*

#017028



**PRO POLISHED
CYLINDER**
Includes polished
2.5 lb cylinder with valve.
#017028 \$169.95



#019297

**10 oz BOTTLE
MOUNT BRACKETS**
Tube mount, 1³/₈" thru 1³/₄"
polished #019297 \$47.95

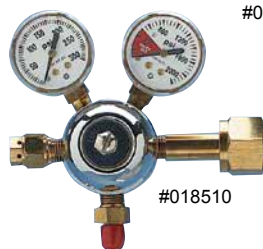

#018510



#019317

PRO CYLINDER PACKAGE
Includes 2.5 lb cylinder with valve &
regulator, two billet bottle mount clamps
with mounting brackets.
#019317 \$279.95
Cylinder with valve only
#019301 \$99.95
Regulator only
#018510 \$114.95



#019917

#007280

#019919

#019918

CO² LINE & FITTINGS
1/4" hose, per foot #019917 \$1.85
Snap lock hose fittings
Straight, 1/8" pipe to 1/4" hose #019918 \$6.95
90-degree, 1/8" pipe to 1/4" hose #019919 \$6.95
1/4 x 1/8 NPT bushing reducer #007280 \$4.20

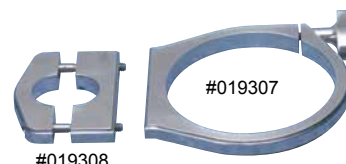

#019308

#019307

2.5 lb BOTTLE MOUNT BRACKETS
Includes easy spin knob for quick bottle changing.
For 2.5 lb. cylinders that are 4-3/8" OD.
#019307 \$54.95
Bar mount, 1.625 diameter, mounts bottle clamp
above without welding #019308 \$34.95



ELECTRICAL COMPONENTS

SWITCHES & ACCESSORIES

14-GAUGE WIRE COILS

Stranded bare copper with crossed link polyethylene jacket which is resistant to grease, oil, gas and acids.

25-ft. each \$9.95

- #019671 Orange
- #019673 Green
- #019675 Violet
- #019669 Black
- #019670 Brown
- #019674 Blue
- #019676 Gray
- #019679 Pink
- #019678 Tan
- #019677 White
- #019672 Yellow



10-GAUGE WIRE

Red #019680 \$14.95



LED INTERIOR LIGHT

Kit includes mounting bracket and one LED light.

#017432 \$17.95

TIMING TERMINAL

Provides an easy & convenient way to connect your timing light.

#017068 \$12.95



TERMINAL BLOCK

8 positions

#018330 \$7.25



MICRO SWITCH PACKAGES

Includes switch, button and mount.

Small button pkg #018995 \$45.95

Large button pkg #019251 \$57.95



#019950

#017064

MICRO SWITCH

Small button

#019950 \$56.95

Large button

#017064 \$59.95

2-Wire cord only

#018650 \$26.95

3-Wire cord only

#018753 \$34.95

SWITCH PANELS & COMPONENTS



#019275

ART DASH MOUNT SWITCH PANEL

Features black anodized laser etched faceplate, heavy-duty push-button starter switch with cap, (4) single light and (1) double light rocker switches. 25-amp rating. Face plate measures 8-1/4" x 3".

#019275 \$114.95



#018019

PAINLESS PERFORMANCE PRODUCTS

Complete kit with 6 circuits, start, ignition, fuel pump, water pump/fan, 2 accessories

#018019 \$249.95

Complete kit with 8 circuits, start, ignition, fan, fuel pump #1 and #2, water pump, lights, accessories

#006360 \$289.95

K & R SWITCH PANEL MOUNT ONLY

Mounts K & R switch panel on either roll bar or roll cage. For 1-5/8" or 1-3/4" tubing.

#017063 \$59.95

K & R SWITCH PANEL

This dash mount kit includes switch panel, rugged fuse & relay panel, laminated diagram, starter solenoid and labeled wire for ease of installation and traceability. All terminals, heat shrink and wire ties included.

Gunmetal #017062 \$579.95

Carbon Illusion #017448 \$599.95



#017062



#019949

ROLL BAR MOUNT SWITCH PANEL

Chromoly panel features roll bar mount provision and black powder-coated finish. Includes heavy duty push-button starter switch with cap and six 20-amp toggle switches. Unique two-piece design utilizes Dzus fasteners allowing easy opening of front panel for maintenance. Includes control panel wiring and lead cable only, additional component wiring must be purchased separately.

#019949 \$189.95

ROLL BAR MOUNT NITROUS SWITCH PANEL

This unit comes with a heavy duty starter button and 6 (20 amp) toggle switches, 2 arming switches and a purge button. Constructed of 4130 chromoly and powder coated for a durable finish. Comes complete with all control panel wiring and lead cable.

#017599 \$349.95



#019712

RELAYS

Relay Only 50 amp

#017332 \$13.95

Single Relay with Harness

#006343 \$22.95

Dual Relay with Harness

#019712 \$54.95

#017332

INDIVIDUAL SWITCHES

On-Off Amber

#018241 \$10.95

On-Off Blue

#018506 \$10.95

On-Off Red

#019240 \$10.95

On-Off-On Red

#019241 \$10.95

Starter Switch, Push Button

#018332 \$14.95

Remote Mount

for Push Button Starter Switch #019607 \$15.00



Switches

#018332

#019607



SALES@APPLIEDRACING.COM

ORDER ONLINE @ WWW.APPLIEDRACING.COM

ELECTRICAL COMPONENTS

WEATHERTIGHT COMPONENTS

MASTER PACK

Includes 1 thru 4, and 6 pin male and female connectors with multiple gauge pins and seals, pin crimping tool, pin removal tool, and compartmentalized storage box. Over 650 pieces.
#019639 \$249.95



#019639

- Connector Set - 1 Pin #019640 \$5.00
- Connector Set - 2 Pin #019641 \$5.50
- Connector Set - 3 Pin #019642 \$5.75
- Connector Set - 4 Pin #019643 \$6.50
- Connector Set - 6 Pin #019644 \$7.00
- Pin Crimping Tool #019646 \$49.95
- Pin Removal Tool #019645 \$13.00

BATTERIES & CHARGERS



#017392



#017505



#019693



#017506

BATTERY - X/S POWER 16 VOLT

AGM Series, 675 cold cranking amps, weighs 46lbs.
10.24" long, 6.75" wide, 7.20" high.
#017392 \$399.95

BATTERY - X/S POWER 16-VOLT LIGHTWEIGHT

AGM Series, 500 cold cranking amps, weighs 31 Lbs.
10.24" long, 6.4" wide, 6.9" high.
#017505 \$399.95

16 VOLT X/S POWER AGM INTELLICHARGER

Compatible with all 16-V AGM batteries, 20-amp output,
2 charging modes.
#019693 \$299.95

16-VOLT X/S POWER COMPACT INTELLICHARGER

Compatible with all 16-V AGM batteries, 15-amp output.
#017506 \$219.95

Special A.R.T. package:
Standard 16-Volt AGM Battery and 20-amp Charger
#017402 \$629.95

SWITCHES

MASTER ON/OFF SWITCHES

Effectively disconnects battery from the rest of the electrical system. Required by sanctioning bodies for safety. **2-Pole**, rated at 175 amps with (2) 3/8" studs (2) 10/32 studs.

#006300 \$36.95

Mounting Bracket for

2-pole switch only

#019007 \$9.50

#006300



#018199



A.R.T. BATTERY DISCONNECT SWITCH KIT

Includes switch, mounting bracket, CNC arm, black anodized push/pull rod with CNC knob.

Complete kit

#018199 \$109.95

Hardware only, no switch

#019098 \$74.95

3-Pole Super Duty,

rated at 300 amps with (2) 1/2" -20 studs.

#019302 \$79.95

#019302



#019077

A.R.T. BILLET ON/OFF SWITCH ARM ONLY

#019077 \$26.95



MONDAY - FRIDAY 8AM - 5PM EST
SALES: 1.800.571.3023 TECH: 727.571.3023

BATTERY MOUNTS & COMPONENTS

ART STARTER QUICK DISCONNECT KIT

2-piece, 1 male and 1 female with 2 terminals and 2 feet of red #4 cable.
#018011 \$59.95



#018011

ART BATTERY CABLE KIT

Kit includes 5 feet #4 black cable, 20 feet #4 red cable, 10 heavy duty cable ends, and 10 Adeil clamps.
#018203 \$89.95

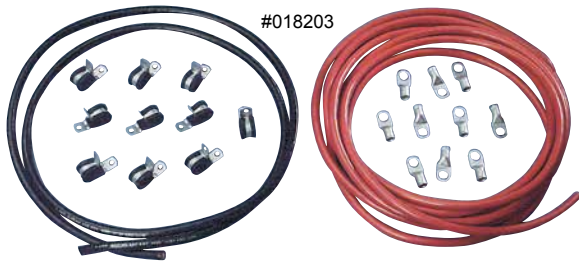

#018203

CHARGING LUGS

Brass construction for excellent conductivity~ Profile assists clip connection. Sold in pairs
#017475 \$28.95

#017475



ART CHARGING LUG KIT

6-piece, 2 male and 2 female, charging set with 2 terminal ends.

#006359 \$99.95

Red receptacle only

#019170 \$30.95

Black receptacle only

#019171 \$30.95

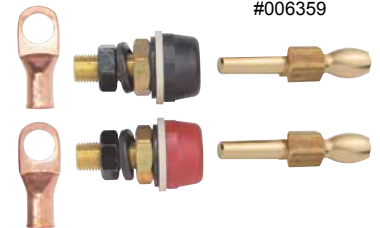

#006359

#4 BATTERY CABLE

Dependable and lightweight.
Sold per foot.

Red #018004 \$3.50

Black #018005 \$3.50

SOLDER TYPE CABLE ENDS

For #4 cable.

3/8" hole #018006 \$2.50

1/2" hole #019992 \$2.95

BATTERY MOUNTS

SPORTSMAN BATTERY MOUNT KIT

Weld in, includes hold-down brackets. Kit mounts 1 #24 series battery. 12" wide x 7 1/4" deep.
#018895 \$34.95



#018895

PRO SINGLE BATTERY MOUNT

All chromoly construction weighs 1-1/4 lbs., designed for group #24 batteries. Adjustable height feature. **TIG welding required.**
#017134 \$89.95



#017134

ART SPORTSMAN SINGLE BATTERY MOUNT

Features mild steel construction with billet hold-down and Grade 8 hardware. Designed for Group #24 batteries.

#017330 \$79.95



#017330



#019157

PRO DUAL BATTERY MOUNT

All chromoly construction weighs 2 lbs., designed for 2 group #24 batteries. Adjustable height feature.

TIG welding required.

#019157 \$120.95



CHASSIS & BODY COMPONENTS

ART ACCESS DOOR KITS

Bolt-in, complete with template, aircraft-quality hardware. Door measures 6" x 6", overall dimensions 8" x 8".

- Clear anodized** #015070 \$64.95
- Carbon** #019926 \$69.95
- Latch only** #018655 \$29.50



ART UNIVERSAL TRANSMISSION CROSSMEMBER KITS

Includes gusseted chassis brackets, trans mount bracket and cross tube. Removable. Kits are unwelded.

- 40" Crossmember** #018324 \$79.95
- 43" Crossmember with 3" drop** #018325 \$99.95

AUTOMATIC TRANSMISSION SHIFTER MOUNT

All chromoly, fully welded with mounting tube and detent pin. #019454 \$59.95



ART SPORTSMAN ENGINE TORQUE LIMITER

Kit contains mild steel engine plate and brackets, aluminum strut rod with 3/8" mild steel rod end and integral clevis and grade 8 hardware. #018323 \$59.95



ART PRO ENGINE TORQUE LIMITER

Kit contains chromoly engine plate and brackets, chromoly strut rod with tube adapters and left and right hand 3/8" chromoly rod ends and all grade 8 hardware.

- Doorslammer** #018937 \$109.95
- Dragster** #018615 \$124.95

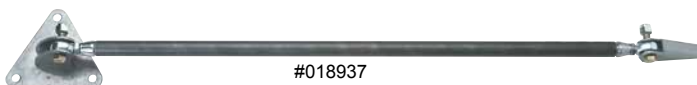

ART ADJUSTABLE WEIGHT BAR

2" x 3" tubing with end caps, fill bung & cap assembly, mounting sleeves, brackets and grade 8 hardware. Length is 24" plus cap & bung. Custom lengths available.

- Unwelded** #017001 \$69.95
- Welded** #018317 \$99.95



ART QUICK REMOVAL FLANGE KIT

Set of four 1-5/8" flanges with grade 8 hardware. A great way to make tubular crossmembers removable. #017388 \$29.95

TRANSMISSION MOUNT

Polyurethane, GM #017055 \$31.95



SHIFTER COMPONENTS

- CO2 Shifter Ram** #019586 \$27.95
- CO2 Electric Activator** #019587 \$58.95
- Shifter Ram Button** #019608 \$8.95



Kit contains chromoly engine plate and brackets, chromoly strut rod with tube adapters and left and right hand 3/8" chromoly rod ends and all grade 8 hardware.

- Doorslammer** #018937 \$109.95
- Dragster** #018615 \$124.95

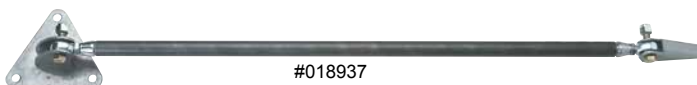

ART ADJUSTABLE WEIGHT BAR

2" x 3" tubing with end caps, fill bung & cap assembly, mounting sleeves, brackets and grade 8 hardware. Length is 24" plus cap & bung. Custom lengths available.

- Unwelded** #017001 \$69.95
- Welded** #018317 \$99.95



ART LEAD PUCK

5 lbs, 3-1/2" x 3-3/4" x 1-1/2", antimony alloy resists deforming and is six times harder than plain lead, pre-drilled with 1/2" mounting hole #019638 \$21.95



ART WEIGHT MOUNT

Designed to mount 2 lead pucks on 1-5/8" tubing, includes 1/2" Grade 8 bolt and washers. #017046 \$29.95



MONDAY - FRIDAY 8AM - 5PM EST

SALES: 1.800.571.3023 TECH: 727.571.3023

CHASSIS & BODY COMPONENTS



ART TUBULAR DRIVESHAFT LOOPS
 1" O.D. tubing with 10" legs. 5-1/2" ID.
Mild steel #018602 \$18.95
Chromoly #018526 \$24.95



ART QUICK RELEASE REMOVABLE DRIVESHAFT LOOP KITS
 Standard driveshaft loop, crossmember, two weld spuds with pins. 5-1/2" ID.
Mild steel #018175 \$49.95
Chromoly #018176 \$54.95



ART SPORTSMAN 360-DEGREE DRIVESHAFT LOOP
 Complete with pins and spuds. 5-1/2" ID.
Mild steel #017154 \$67.95

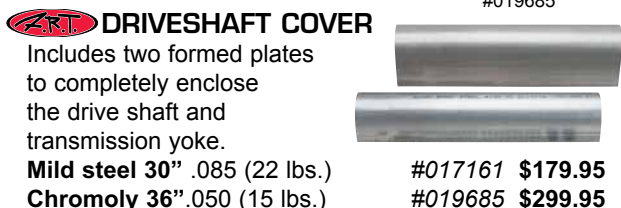

ART DRIVESHAFT COVER
 Includes two formed plates to completely enclose the drive shaft and transmission yoke.
Mild steel 30" .085 (22 lbs.) #017161 \$179.95
Chromoly 36" .050 (15 lbs.) #019685 \$299.95



PRO 360-DEGREE DRIVESHAFT LOOP
 Complete with pins, spuds and mounting accessories. 5-1/4" ID.
Chromoly #019029 \$148.95



ART MILD STEEL DRIVESHAFT ENCLOSURE KIT
 Includes 30" upper & lower formed cover halves, two unwelded 360-degree m/s driveshaft loops and mounting hardware.
#017162 \$329.95



CHROMOLY DRIVESHAFT ENCLOSURE KIT
 Includes 36" upper and lower formed chromoly cover halves, two unwelded 360-degree chromoly driveshaft loops and mounting hardware.
#017325 \$499.95



REAR CHASSIS DRIVESHAFT LOOP ENCLOSURE KIT
 Includes 1" x .058" fully welded chromoly loop with four mounting tubes for welding to rear chassis tail section. Must be mounted within 6" of rear U-Joint, allows easy access to U-Bolts. Inside dimensions 10-3/4" tall x 5-1/4" wide.
#017571 \$169.95

ART FRONT END TO CHASSIS MOUNTING KITS
 These universal kits include all tubing, brackets and mounting hardware.
Mild steel #018306 \$134.95
Chromoly #018307 \$274.95



ART SPORTSMAN FRONT END TO BODY MOUNTING KIT
 Includes 6 weld-on plates, springs & self-eject fasteners, mild steel tubing and bending fixture.
#018979 \$114.95

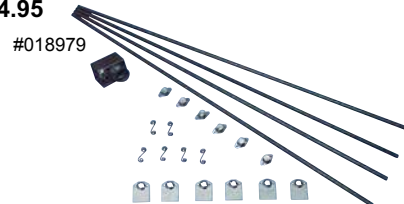

PRO BODY MOUNT KIT
 Includes chromoly tubing and body mounting plates necessary to mount roof and quarter panels to chassis.
#019665 \$174.95

PRO FRONT END TO BODY MOUNTING KIT
 Includes 8 weld-on plates, Pro Stock style self-eject fasteners and springs, with pre-bent chromoly tubing.
#019604 \$119.95

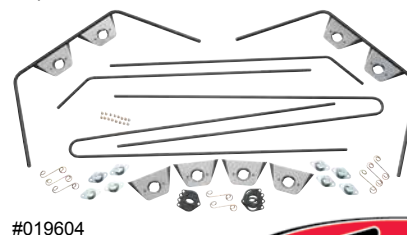

WINDOW ACCESSORIES

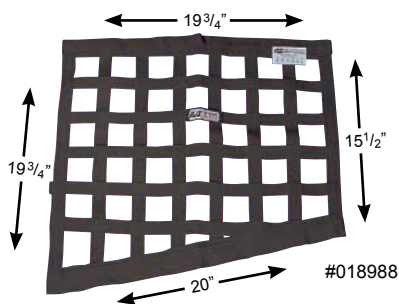

ANGLED WINDOW NETS

SFI approved.
Black #018987 \$25.95

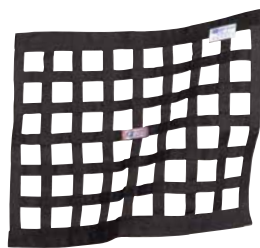

RIBBON WINDOW NETS

SFI approved, 18" x 24".
Black #018710 \$26.00

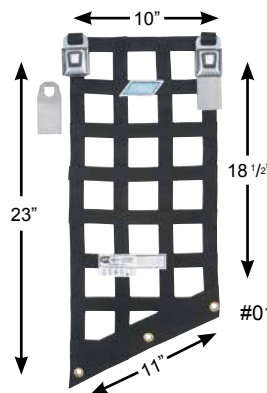

FUNNY CAR WINDOW NET

SFI approved, includes dual latches for installation and function of the top of the net.
#019859 \$124.95



FUNNY CAR WINDOW NET LOWER MOUNT KIT

The hardware included with our funny car net provides for the installation and function of the top of the net. This kit is required to attach the lower edge of the net to your roll cage, and does not provide for upper net attachment.
#019860 \$19.95

WINDOW NET INSTALLATION KITS

Complete with hardware as shown.

Sportsman

Mild steel construction.
#018709 \$33.95

ART Pro

Chromoly construction with upper rear pivot design for convenient operation.
#019244 \$84.95

PRO PLUS FUNNY CAR WINDOW NET MOUNT

Meets NHRA requirement for Pro Stock and Pro Mod, designed for horizontal upper and lower loop style window nets. A spring-loaded rear pin allows the driver to latch or release the net with one motion for easy entry and exit. Window nets are sold separately.

TIG welding required.

#019801 \$149.95

Window Net Latch Only

#019238 \$24.95

#019238

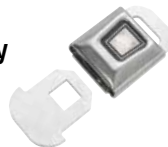

ART WINDOW INSTALLATION KITS

This package comes complete with 15' rubber gasket material and all required stainless steel installation hardware.

1/4" rubber #018702 \$44.95

3/8" rubber #019322 \$57.95

1/2" rubber #019332 \$69.95



#018702

COUNTER-SINK TOOL

Adjustable depth 82-degree bit countersinks your window material to enable flush-mounting of hardware.
#019507 \$69.95



#019507

ART WINDOW FRAME KIT

This kit enables the fabricator to shape and bend a custom frame for mounting Lexan side windows on any car. Includes bending jig fixture, weld-on tabs, 22' of 5/16" x .058" DOM straight tubing and all necessary stainless steel hardware. 1 kit frames 2 windows.
#018563 \$119.95



#018563

KITS DO NOT COME PRE-BENT

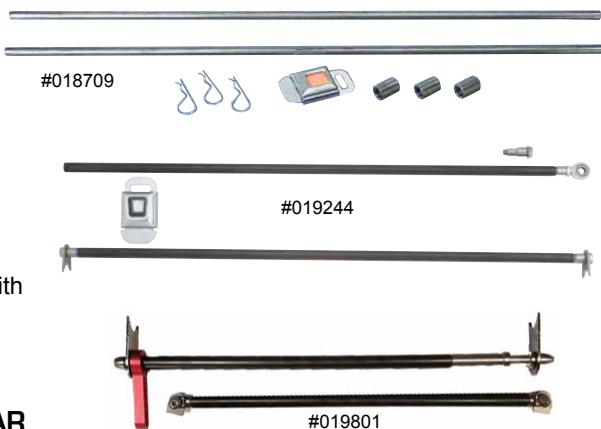

#018709

#019244

#019801

LEXAN SHEET

Abrasion resistant MR10/AR2. Pre-cut 1/8" x 32" x 72" with protective covering.
#019857 \$199.95

#019786

WINDOW DIAL-IN MARKER

#019786 \$6.95



PLEXUS WINDOW CLEANER

#019779 \$28.95

Ships UPS Ground Only

#019779



WINDOW BORDER PAINT

#019780 \$19.95

Ships UPS Ground Only

#019780



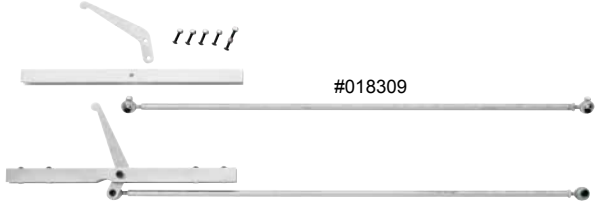

#018309

ART DOOR RELEASE KITS

Includes ergonomically correct handles, linkage with hardware and mounting channel. (Pair)

Sportsman #018309 \$84.95

Includes ergonomically correct anodized handles, quick release linkage with rods, mounting channel and hardware for attachment to interior. (Pair)

Pro #019032 \$89.95



#019032

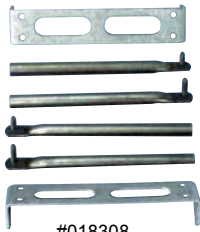

#018308

SPORTSMAN DOOR HINGE KIT

These easy to install one-piece hinges are considerably lighter than OEM units. Includes mounting hardware. (Pair)

#018308 \$99.95



#019030

PRO DOOR HINGE KIT

All chromoly, perfect for lightweight fiber glass or carbon fiber doors and includes mounting hardware. (Pair)

#019030 \$159.95



#019781

DOOR PANEL FASTENER KIT

#019781 \$59.95

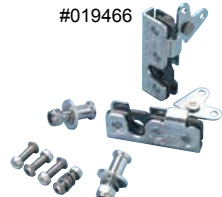

#019466

ART DOOR LATCH KITS

Comes complete with latches, strikers and hardware. (Pair)

Slimline Kit #019466 \$84.95

Billet Kit #017604 \$329.95



#019654

ART STRIKER PLATES

These 4130 chromoly laser-cut plates are designed to be used with the slimline latch kit to protect the inner doorjamb and give a professional installation. (Pair)

Slimline Latches #019654 \$24.95

Billet Latches #017605 \$24.95

#019605



DOOR STRIKER MOUNT KIT

The preferred way to mount striker pins when using a fiberglass body. Tubes weld to chassis, striker pin attaches to mounting plate. (Pair)

#019605 \$44.95

ART DOOR MOUNT PACKAGE SPORTSMAN

Includes Sportsman Door Release Kit, Sportsman Door Hinge Kit, Slimline Door Latch Kit and Door Safety Strap Kit.

#017316 \$289.95



#017316

ART DOOR MOUNT PACKAGE PRO

Includes Pro Door Release Kit, Pro Door Hinge Kit, Slimline Door Latch Kit with Striker Plates and Door Safety Strap Kit.

#017482 \$359.95



#017482



DOOR COMPONENTS



UPPER DOOR/WINDOW LATCH

Complete with chromoly loops and hardware, allows functional release from either side of window. (Pair)
#019031 \$189.95

TOW HOOK ASSEMBLY

Includes quick release pin, mounting tube with chrome plated attachment ring.
With 3/8" pin #019034 \$59.95
With 1/2" pin #017360 \$89.95

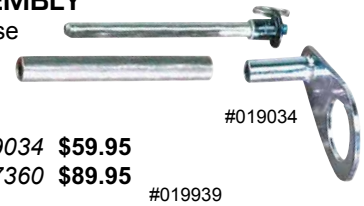

ART DOOR SAFETY STRAP KIT

Includes strap, mount and hardware for two doors.
#019361 \$44.95



TOW STRAP

Retractable 16' strap, features Quick Disconnect loop for easy attachment to roof hook, chassis or handlebars.
#019939 \$139.95



ART PUSH BAR KIT

1-1/8" x .083 x 6' chromoly tubing with tube end adapters, high-angularity rod ends, 1/2" push-pull pins and choice of mounting options.
#017382 \$149.95



PRO PUSH BAR KIT

Collapsible design for easy storage. Extends to 87" long. Designed to work with pro chute and tether mount. Easy bolt on installation. Includes bar and all mounting hardware.
Tether mount not included.
#017447 \$249.95



BILLET PUSH BAR MOUNTS

For use with Pro Single and Dual Chute Mount Kits.
Single #017501 \$99.95
Dual #017502 \$124.95

PEDALS & ACCESSORIES

SPORTSMAN SERIES

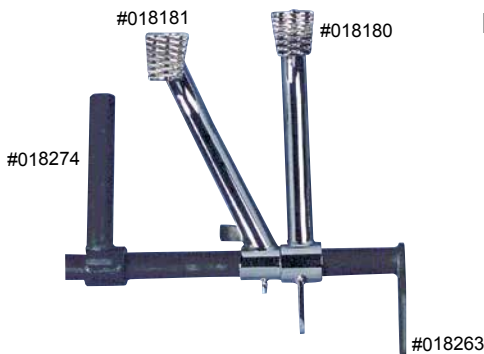

SPORTSMAN SERIES BRAKE & CLUTCH PEDALS

These pedals are designed to give proper leverage; clutch pedal is angled for clearance, and brake pedal is bushed for smooth operation and easy installation.

- Brake pedal, chrome, with expanded metal face #018180 \$74.95
- Clutch pedal, chrome, with expanded metal face #018181 \$79.95
- Pedal cross shaft #018263 \$24.95
- Pedal cross shaft support, short #018293 \$14.95
- Pedal cross shaft support, long #018274 \$16.95
- Brake pedal rod (3/8" thread) #018525 \$28.95
- Clutch linkage kit #018283 \$26.95
- Clutch stop, adjustable #018284 \$29.95

SPORTSMAN THROTTLE PEDAL COMPONENTS

Engineered with proper ratio to allow smooth throttle opening.

ART THROTTLE PEDAL MOUNT KIT

#018276 \$18.95



GAS PEDAL

Chrome, with expanded metal face
#018179 \$74.95



ART THROTTLE PEDAL STOP KIT

#018277 \$29.95

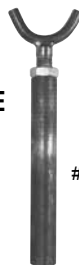

THROTTLE LINKAGE KIT

Included 23" tube can be cut or bent. 1/4"-28 tap required
#018278 \$54.95

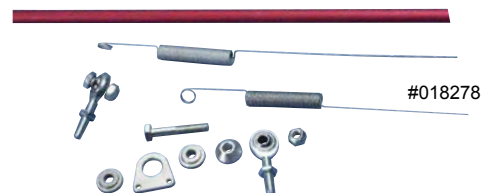

PEDALS & ACCESSORIES

PRO SERIES

PRO BRAKE & CLUTCH PEDALS

4130 Construction with correct ratio for Chrysler style master cylinder. Clutch pedal is angled for clearance.

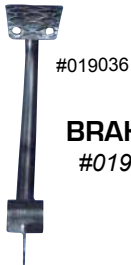

019036
BRAKE PEDAL
#019036 \$84.95

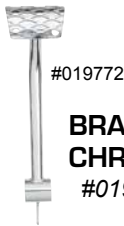

019772
BRAKE PEDAL, CHROME
#019772 \$124.95



019037
CLUTCH PEDAL
#019037 \$84.95



019769
CLUTCH PEDAL, CHROME
#019769 \$124.95



018282
ART BRAKE ROD KIT
#018282 \$33.95

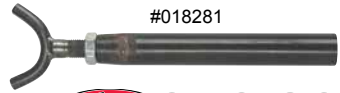

018281
ART CLUTCH STOP, ADJUSTABLE
#018281 \$34.95



019026
PEDAL CROSS SHAFT w/bearings
#019026 \$79.95
Pedal bearing only
#019086 \$10.95



019450
PEDAL BOOT
#019450 \$38.95



018280
ART CLUTCH LINKAGE KIT UNWELDED
#018280 \$39.95



017029
CLUTCH SWITCH
#017029 \$169.95

PRO THROTTLE PEDAL COMPONENTS

All 4130 construction with proper pedal offset and ratio.



017069
THROTTLE PEDAL TOE HOOK
#017069 \$69.95



019035
GAS PEDAL
#019035 \$84.95

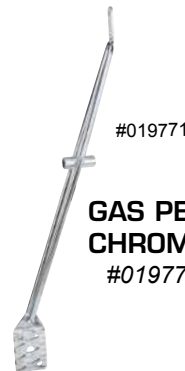

019771
GAS PEDAL, CHROME
#019771 \$124.95



018290
THROTTLE PEDAL MOUNT KIT
#018290 \$34.95



018291
ART THROTTLE PEDAL STOP KIT
#018291 \$34.95



019751
THROTTLE LINKAGE BOOT
2" diameter ring
#019751 \$20.95



018292
ART THROTTLE LINKAGE KIT
#018292 \$49.95

UNIVERSAL PEDAL ASSEMBLIES

BRAKE PEDAL AND MASTER CYLINDER MOUNTING ASSEMBLY

All aluminum bolt-in self contained unit for use with single or dual reservoir master cylinder. Easy to install.

Single floor mount pedal assembly #015120 \$99.50

Dual floor mount pedal assembly #015121 \$149.95



MASTER CYLINDER ADAPTER KIT

Allows the use of a Chrysler style master cylinder with the Wilwood floor-mount brake pedal.
#019023 \$52.95



Single & Dual Swing-Mount Pedal Assemblies Available.



MOTOR & MID PLATES



UNIVERSAL MOTOR PLATES

These CNC machined 1/4" 6061-T6 aluminum plates offer a professional appearance with ease of installation.

SB Chevy	#018660	\$159.95
BB Chevy	#005851	\$159.95
w/ Raised Cam	#017485	\$179.95
SB Ford	#018232	\$159.95
w/ Aftermarket Block	#017481	\$159.95

Cleveland	#018233	\$159.95
BB Ford	#018231	\$159.95
SB Mopar	#018230	\$159.95
BB Mopar	#018229	\$159.95
Blank 12" x 36"	#018990	\$139.95
LS Two Piece	#017383	\$169.95



PROFILE MILLED MOTOR PLATES

These CNC machined 1/4" 6061-T6 aluminum plates offer a lightweight professional appearance with ease of installation.

NOTE: Other applications available.

SB Chevy	#018957	\$169.95
BB Chevy	#018958	\$169.95

PRO MOTOR PLATE MOUNT KIT

Universal kit, all moly components, includes 1/2" moly support tube with NAS hardware.

TIG welding required.

#019154 \$45.95



PRO MID PLATE MOUNT KIT

Features moly tube with lightweight moly plate, NAS bolts & hardware.

TIG welding required.

#019155 \$84.95



180° STEEL MID MOUNTS

Plates are made from .090" mild steel, are 29" wide and can be trimmed to fit any chassis.

Big & small block Chevy	#018318	\$44.95
Big block Ford (460)	#018319	\$74.95
Small block Ford	#018320	\$74.95
Big block Mopar	#018321	\$74.95
Small block Mopar	#018322	\$74.95
LS	#017407	\$69.95

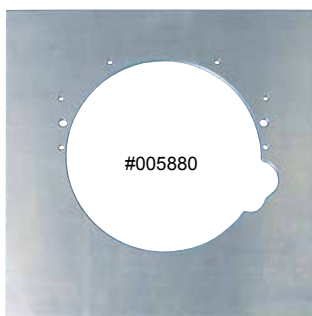

FULL MID MOUNT PLATE

1/4" thick 6061 aluminum 24" x 24" precision machined dowel pin, vent, crank and bolt holes.

SBC and BBC	#005880	\$199.95
Blank 24" x 24"	#019684	\$149.95

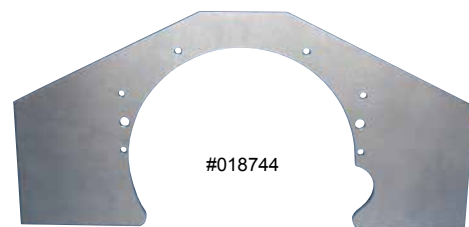

BBC & SBC BODIED CAR STYLE

1/4" thick 6061 aluminum, 30" wide x 14 1/2" tall.

#018744 \$189.95



PARACHUTES & ACCESSORIES

STROUD CHUTES



#019276

NOTE: Specify vehicle weight, type and maximum MPH in order to determine correct chute application.

SUPER COMP

- Black #019279 \$359.95
- Red #019280 \$359.95
- Blue #019281 \$359.95

SUPER GAS

- Black #019282 \$409.95
- Red #019283 \$409.95
- Blue #019284 \$409.95

PRO STOCK

- Black #019276 \$464.95
- Red #019277 \$464.95
- Blue #019278 \$464.95

REMOVE BEFORE FLIGHT TAG

- #019968 \$14.95



#019439

PRO STOCK CHUTE WITH LAUNCHER

- Black- Spring #019439 \$849.95
- Black- Air #017464 \$849.95

PRO STOCK DUAL CHUTE WITH LAUNCHER

Specifically sized smaller for applications where two chutes are required, includes two chutes, each with spring launchers.

- Black #019782 \$1699.95

ART SPRING LAUNCHER WRENCH

Designed for use with Stroud spring launchers, this crank wrench simplifies compression of launcher spring and eliminates the need for ratchets with multiple extensions. Features easy-turn sleeve design, black powder-coated finish and twelve-point 15/16" socket. 55" overall length.

- #017555 \$109.95

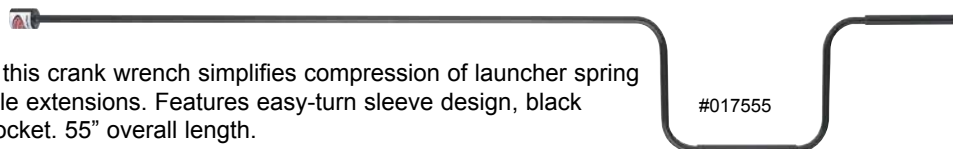

#017555

CHUTE MAINTENANCE ACCESSORIES

SMALL DEPLOYMENT BAG

For Standard Pilot, Super Comp & Super Gas.

- #017589 \$55.95

LARGE DEPLOYMENT BAG

For Standard Pilot, Comp Eliminator & Pro Stock.

- #017590 \$55.95

SMALL LAUNCHER DEPLOYMENT BAG

For Super Comp & Super Gas.

- #017591 \$89.95

LARGE LAUNCHER DEPLOYMENT BAG

For Comp Eliminator & Pro Stock.

- #017592 \$89.95

PILOT CHUTE, SMALL

For Super Comp & Super Gas.

- #017596 \$91.95

PILOT CHUTE, LARGE

For Comp Eliminator & Pro Stock.

- #017597 \$96.95



#017596



#017589



#017592



#017593

SMALL CHUTE PACK

For Standard Pilot, Super Comp & Super Gas

- #017593 \$68.95

LARGE CHUTE PACK

For Standard Pilot, Comp Eliminator & Pro Stock.

- #017594 \$68.95

CHUTE PACK, LAUNCHER STYLE

For small or large chutes and spring or air applications. Must specify application when ordering.

- #017595 \$68.95



PARACHUTES & ACCESSORIES

CHUTE RELEASE KITS & HANDLES



#018197

SPORTSMAN
Includes 6061-T6 aluminum release handle, chassis pivot, cable clamp weld bracket and all other necessary hardware. 12-foot cable included.
#018197 \$94.95



#019192

PRO
Includes 6061-T6 aluminum release handle, quick release ball joint, cable clamp, mounting bracket, 12-foot cable with end cap, and all necessary hardware.
#019192 \$114.95



#019540

DUAL
Releases both chutes at once; includes 6061-T6 aluminum release handle, two quick-release ball joints, dual cable clamp, mounting bracket, two 12-foot cables with end caps and all necessary hardware.
#019540 \$199.95



#017066

PNEUMATIC
Allows deployment of chutes from the steering wheel by the simple push of a button. Kit includes ram, button with cord, poly tubing, snap-lock hose fittings and mounting hardware. Chute release handle and cables are sold separately.
#017066 \$179.95



#018210

CHUTE HANDLE - SPORTSMAN
1/8" Aluminum, 1 1/4" wide, 10" long.
#018210 \$5.95



#019201

CHUTE HANDLE - PRO
1/4" Aluminum, 1 1/4" wide, 9" long.
#019201 \$24.95



#017512

CHUTE HANDLE - EXTREME
1/4" Aluminum, 1 1/4" wide, 9" long.
#017512 \$29.95



#017529

CHUTE HANDLE - CARBON FIBER
1/4" Carbon fiber, 1 1/8" wide, 8 1/2" long.
#017529 \$39.95

CHUTE MOUNT KITS



#017400

SPORTSMAN
Includes formed pack mount and tether mount provisions, brackets and necessary hardware to securely mount both the parachute pack and tether. **New design will accommodate either standard or launcher style chute.**
Welding required.
#017400 \$119.95



#019533



PRO SINGLE
All chromoly, fully welded pack assembly with tether mounting provision and NAS hardware with accessories.
#019033 \$224.95

#019033

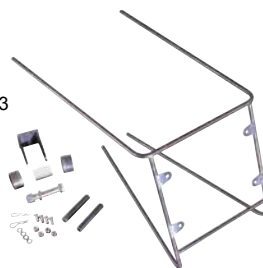

PRO DUAL
Includes pre-bent adjustable width chromoly frame, fully-welded chromoly dual tether mount with NAS hardware, chute pack mounting brackets and mounting rods with hardware.
TIG welding required.
#019533 \$239.95

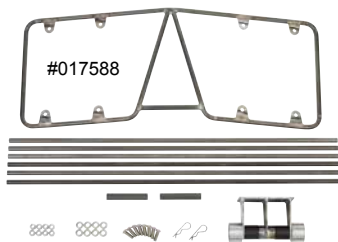

#017588

PRO WELDED DUAL
Features welded chromoly frame with chute pack mounting brackets and welded tether mount assembly. Mounting tubes, NAS tether hardware and pack mount hardware included.
TIG welding required.
Small Dual #017587 \$284.95
Large Dual #017588 \$284.95



#017462

STREET/STRIP REMOVABLE CHUTE MOUNT
Mild steel components. Easily removable for street legal driving.
Welding required.
Rear bumper bar sold separately.
#017462 \$109.95



MONDAY - FRIDAY 8AM - 5PM EST
SALES: 1.800.571.3023 TECH: 727.571.3023



#005624

TRANSMISSION MOUNT BRACKET

1/8" material with slotted holes, pre-notched to 13/16" radius.
#005624 \$7.25



#015182

PANHARD BAR HOUSING BRACKET

3/16" MS, 8 1/4" long, 1 1/4" wide, 3 1/4" tall.
#015182 \$28.95

EXTRA SMALL UNIVERSAL BRACKETS

1/8" MS, 3/8" hole, 1" tall, 1 1/4" wide, 5/8" radius #015206 \$1.25
1/8" CM, 3/8" hole, 1" tall, 1 1/4" wide, 5/8" radius #015006 \$1.65

#015206

#015183

MEDIUM UNIVERSAL BRACKETS

3/16" MS, 1/2" hole, 1 3/4" tall, 1 5/8" wide, 13/16" radius #015183 \$2.40
1/8" CM, 1/2" hole, 1 3/4" tall, 1 5/8" wide, 13/16" radius #015184 \$4.90

SMALL UNIVERSAL BRACKETS

1/8" MS, 3/8" hole, 1 1/2" tall, 1 1/4" wide, 5/8" radius #015193 \$1.60
.090 CM, 3/8" hole, 1 1/2" tall, 1 1/4" wide, 5/8" radius #015194 \$3.15

#015193

#015185

LARGE UNIVERSAL BRACKETS

3/16" MS, 1/2" hole, 2 1/2" tall, 2" wide, 13/16" radius #015185 \$3.50
1/8" CM, 1/2" hole, 2 1/2" tall, 2" wide, 13/16" radius #015186 \$6.95
3/16" MS, 1/2" hole, 3 1/4" tall, 2" wide, no radius #015187 \$3.95



#005644

RACK & PINION MOUNT BRACKET

One piece construction, 1/8" material, pre-notched to 13/16" radius, with 7/16" mounting holes.

Right hand #005644 \$6.00
Left hand #005645 \$6.00

#015188

EXTRA LARGE UNIVERSAL BRACKET

3/16" MS, 1/2" hole, 3" tall, 2 1/2" wide with 1 1/2" radius #015188 \$4.95



#018809

SPORTSMAN WHEELIE BAR FOOT BOX

#018809 \$32.50

#015190

FLAT BASE UNIVERSAL BRACKETS

3/16" MS, 1/2" hole, 1 7/16" tall, 1 1/2" wide #015190 \$1.75
1/8" CM, 1/2" hole, 1 7/16" tall, 1 1/2" wide #015191 \$3.45



#019226

SPORTSMAN WHEELIE BAR FOOT BOX GUSSET

#019226 \$3.75

#015192

UNIVERSAL FRAME MOUNT BRACKETS

1/8" MS, no hole, 1 7/8" tall, 1 3/8" wide, 3/4" radius #015192 \$7.50
1/8" CM, no hole, 1 7/8" tall, 1 3/8" wide, 3/4" radius #015005 \$14.35

PRO WHEELIE BAR FOOT BOX KIT

#019618 \$59.95



#019618

#015197

#015050

WELD-IN CLEVIS BRACKET

1/8" CM, 3/8" hole, 1 1/2" tall, 1" wide #015050 \$3.75



#005615

WHEELIE BAR TO HOUSING BRACKET

3/16" MS, 1 1/2" radius, easily modified to fit larger axle tubes.
#005615 \$21.95

#017498

WINDOW MOUNT BRACKET

1/16" MS, 3/16" hole, 3/4" tall, 3/4" wide, 25 per pack.
#015197 \$12.95



QUICK REMOVAL FLANGE

3" x 3" x 3/16" mild steel, for use with 1-5/8" tubing.
#017498 \$7.50



BRACKETS



GUSSETED CHASSIS BRACKETS

- 1/8" MS, 3/8" hole, 1 1/2" wide, 1 5/8" tall, 13/16" radius #005613 \$3.50
- 1/8" CM, 3/8" hole, 1 1/2" wide, 1 5/8" tall, 13/16" radius #005614 \$5.95
- 1/8" MS, 1/2" hole, 1 1/2" wide, 1 5/8" tall, 13/16" radius #018237 \$3.50
- 1/8" CM, 1/2" hole, 1 1/2" wide, 1 5/8" tall, 13/16" radius #018934 \$5.95



- BALL JOINT HOUSING**
- #018254 \$32.95
- Ball Joint**
- #008640 \$26.95



RADIUS ROD ENGINE LIMITER BRACKET

- .100 CM, 3/8" hole, 3 1/4" long, 3/4" wide
- #005628 \$5.75

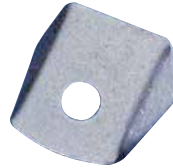

BELLCRANK MOUNT BRACKETS

- .100 MS, 1/4" hole, 1 1/2" tall, 1 1/2" wide #018760 \$1.95
- .100 MS, 3/8" hole, 1 1/2" tall, 1 1/2" wide #015198 \$1.95



CROSSMEMBER BRACE BRACKETS

- 3/16" MS, 5/16" hole, 1" tall, 1 5/8" wide #015200 \$1.50
- 1/8" MS, 5/16" hole, 1" tall, 1 5/8" wide #015201 \$1.50

#015198



DIAGONAL LINK BOLT-ON BRACKETS

- 3/16" MS, 1/2" diagonal link hole, 5/8" mounting hole, 1 1/2" wide, 2 1/4" long #015202 \$7.95
- 3/16" MS, 1/2" diagonal link hole, 3/4" mounting hole, 1 1/2" wide, 2 1/4" long #015203 \$7.95

#015204

ANTI-ROTATION BRACKETS

- 1/8" MS, 3/8" hole, 1 3/4" tall, 1 3/4" wide #015204 \$1.50
- 1/8" CM, 3/8" hole, 1 3/4" tall, 1 3/4" wide #015003 \$4.95
- 1/8" CM, 1/2" hole, 1 3/4" tall, 1 3/4" wide #019508 \$4.95



BILLET DIAGONAL LINK MOUNT

- 5/8" - 18 Thread. Accepts 1/2" hole rod end. #019306 \$34.95
- 3/4" - 16 Thread. Accepts 1/2" hole rod end. #017452 \$34.95



DOOR HANDLE - SPORTSMAN

- 1/8" Aluminum, 3/4" wide, 5 1/4" long. #017143 \$6.95



DOOR HANDLE - PRO

- 1/8" Aluminum, 3/4" wide, 5 1/4" long. #019830 \$10.95



CHUTE HANDLE - SPORTSMAN

- 1/8" Aluminum, 1 1/4" wide, 10" long. #018210 \$5.95



CHUTE HANDLE - PRO

- 1/4" Aluminum, 1 1/4" wide, 9" long. #019201 \$24.95

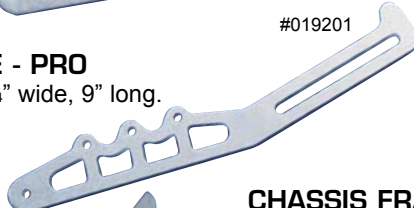

FRONT A-ARM LOWER BRACKET

- 3/16" MS, 1/2" hole #005673 \$12.95



CHASSIS FRAME GUSSET

- #019763 \$9.95



#018271

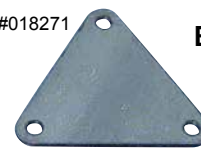

ENGINE LIMITER BRACKET

- 3/16" MS, 3/8" holes. #018271 \$11.95

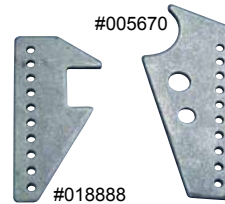

ADJUSTABLE SHOCK MOUNT HOUSING BRACKETS

- 1/4" MS, 3/8" holes with 1 1/2" radius #005670 \$13.95
- 1/4" MS, 3/8" holes with notch for 2 x 3 housing brace #018888 \$18.95

BOLT-ON SHOCK MOUNT BRACKETS

- Left hand, 3/16" MS, 3/8" holes #017550 \$14.95
- Right hand, 3/16" MS, 3/8" holes #017551 \$14.95
- Straight, 3/16" MS, 3/8" holes #018114 \$14.95

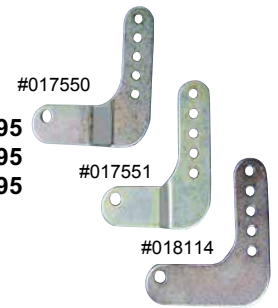

FRONT END MOUNTS

- Chassis Mount Guide, CM #019256 \$9.95
- Centering Tab, CM #019257 \$7.95
- Body Mount Plate, CM #019258 \$5.95
- Body Mount Plate, MS #019386 \$5.75



MONDAY - FRIDAY 8AM - 5PM EST

SALES: 1.800.571.3023 TECH: 727.571.3023



4-LINK HOUSING BRACKETS
1/4" MS, 5/8" holes, 3 1/4" axle tube diameter
#005660 \$29.95
1/4" CM, 5/8" holes, 3 1/4" axle tube diameter
#005660CM \$54.95

HOUSING ADAPTER RING

Allows use of 3 1/4" OD housing brackets on 3" axle tubes.
 Allow one ring per bracket. **#018270 \$8.95**

4-LINK CHASSIS BRACKETS
For Round Tube Frame Rails

1/4" MS, 5/8" holes, 13/16" radius
#005650 \$19.95
1/4" CM, 5/8" holes, 13/16" radius
#005650CM \$49.95



A.R.T./J.B.R.C. 4-LINK BRACKETS

CHASSIS BRACKETS
1/4" MS, 5/8" holes
#019267 \$29.95
1/4" CM, 1/2" holes
#019532 \$64.95

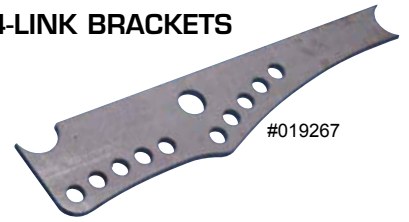

HOUSING BRACKETS

1/4" MS, 5/8" holes,
3-1/4" axle tube
#019274 \$29.95
1/4" CM, 1/2" holes,
3-1/4" axle tube
#019531 \$74.95



4-LINK CHASSIS BRACKET
For 2" x 3" Frame Rails

1/4" MS, 5/8" holes
#019827 \$19.95



CHRYSLER STYLE MASTER CYLINDER MOUNT BRACKET

3/16" MS, 1 5/8" hole with 13/16" rear radius.
#018264 \$26.95

BRACKET STRAPS

Straps install between brackets for added rigidity.
 Suitable for mild steel or chromoly brackets.

A.R.T. 4-link housing bracket strap 3/4" #019503 \$6.25
Universal Lightweight Strap 24" x 1" #017079 \$9.95

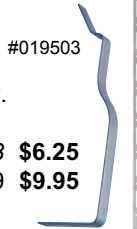

DRAGSTER STEERING WHEEL BRACKET

.065 CM, 2 3/8" long, 1 1/2" wide
#015051 \$4.25



LADDER BAR BRACKET
For 2" x 3" Crossmember

1/4" MS, 5/8" holes
#005661 \$10.95

WHEEL ADAPTER BRACKET - 3 HOLE

1/8" MS, 2 1/2" diameter, 3/4" center hole, 1/4" steering wheel bolt holes.
#018223 \$9.95



PARACHUTE MOUNTING BRACKET Dragster/Altered

1/8" Mild steel
#018272 \$19.95



LADDER BAR BRACKETS
For Round Tube Crossmember

1/4" MS, 1 3/4" large hole, 5/8" holes
#018536 \$14.50

1/4" MS, 1 3/4" large hole, 3/4" holes
#018455 \$14.50

1/4" CM, 1 3/4" large hole, 3/4" holes
#017460 \$22.95



STEERING WHEEL ADAPTER

4130 bracket designed to allow installation of the 5-hole Grant wheel on a 3-hole quick-disconnect.
#019027 \$14.95



LINE LOCK MOUNT

Fits TCI or Hurst style line lock
#019627 \$6.85



LADDER BAR HOUSING BRACKETS

1/4" MS, 5/8" holes, open center, no optional shock mount holes
#018454 \$18.95

1/4" MS, 3/4" holes, open center, no optional shock mount holes
#019630 \$18.95

1/4" MS, 5/8" holes, open center, with optional shock mount holes
#018911 \$19.95



SHOCK SPUD-CHROMOLY

.875 x 1.500, machined 1/2 - 20 thread, designed for use with A.R.T. / J.B.R.C. 4-link brackets.
#019453 \$13.95



6" x 6" ROLL CAGE PLATE BRACKET

1/8" Mild steel #018273 \$7.95



STEEL TUBING & ROD ENDS

TUBING & PLATE

A.R.T. purchases steel in high-volume contract orders which allows us to specify certain mills as the source of our tubing. A.R.T. does not stock material melted or produced from Asian sources. All steel tubing is tracked by heat batch and carries certifications for alloy, grade and mechanical properties.

All tubing must be prepaid and is not returnable.

4130 TUBING

Steel#	O.D.	Wall	Price Per Foot
#1	1/4"	.049"	\$7.95
#2	5/16"	.058"	\$7.95
#3	3/8"	.058"	\$5.95
#5	1/2"	.058"	\$4.95
#6	5/8"	.058"	\$4.95
#7	3/4"	.058"	\$4.95
#8	7/8"	.058"	\$5.95
#10	1"	.058"	\$5.95
#11	1"	.065"	\$5.95
#12	1 1/8"	.058"	\$5.50
#13	1 1/8"	.065"	\$5.95
#14	1 1/8"	.083"	\$8.95
#16	1 1/4"	.058"	\$6.50
#17	1 1/4"	.065"	\$6.75
#18	1 1/4"	.083"	\$7.95
#19	1 1/4"	.095"	\$7.30
#20	1 1/4"	.120"	\$9.95
#21	1 3/8"	.058"	\$8.50
#23	1 3/8"	.095"	\$8.95
#24	1 1/2"	.058"	\$7.95
#25	1 1/2"	.065"	\$8.95
#60	1 1/2"	.120"	\$10.95
#26	1 5/8"	.083"	\$8.50
#57	1 3/4"	.083"	\$9.95
#27	3 1/4"	.250"	\$59.95

MILD STEEL TUBING

Round Steel#	O.D.	Wall	Price Per Foot
#28	1/2"	.065"	\$1.95
#29	5/8"	.065"	\$3.75
#30	3/4"	.083"	\$2.95
#31	1"	.083"	\$2.95
#32	1 1/4"	.083"	\$2.95
#33	1 1/4"	.120"	\$3.50
#34	1 1/2"	.120"	\$7.45
#35	1 5/8"	.134"	\$5.50
#36	1 3/4"	.134"	\$5.95

Rectangular Steel#	O.D.	Wall	Price Per Foot
#51	2" x 3"	.083"	\$6.95
#52	2" x 3"	.120"	\$7.95

4130 PLATE

Steel#	Thickness	Price Square Foot
#53	.080"	\$34.95
#54	.125"	\$49.95

*All 4130 plate is cut 18" wide.
One square foot is cut 18" x 8".*



4130 TUBING BARGAIN BOX

Sizes vary from 1/4" x .049 to 1-3/4" x .083. +/- 15 lbs of tubing per box. 24" max length.
#017451 **\$19.95**

DOM TUBING

Steel#	O.D.	I.D.	Wall	Tap	Price Per Foot
#37	5/16"	.199"	.058"		\$6.25
#39	1/2"	.260"	.120"	5/16"-24	\$4.50
#41	5/8"	.385"	.120"	7/16"-20	\$5.50
#42	3/4"	.510"	.120"		\$5.50
#43	3/4"	.438"	.156"	1/2"-20	\$5.95
#46	1"	.760"	.120"		\$5.95
#47	1"	.688"	.156"	3/4"-16	\$7.95
#48	1 1/4"	1.010"	.120"		\$7.50
#58	1 5/8"	1.385"	.120"		\$9.95
#50	3 1/4"	2.874"	.188"		\$49.95

6061 T-6 PLATE

Steel#	Thickness	Price Square Foot
#56	.250"	\$29.95

WELDING ROD

4130 Tig rod, per pound
#019810 **\$11.95**
(Approx. 30 rods per pound.)

Other sizes and quantity discounts available.



ROD ENDS

FK MILD STEEL ROD ENDS

Hole/Thread	Type	FK #	Static Load Capacity Lbs	Price
10/32"	left	CML3	1,210	#017335LM \$3.25
	right	CM3	1,210	#017335RM \$3.25
1/4"	left	CML4	2,225	#017336LM \$3.25
	right	CM4	2,225	#017336RM \$3.25
5/16"	left	CML5	3,600	#017337LM \$3.70
	right	CM5	3,600	#017337RM \$3.70
3/8"	left	CML6	5,100	#017338LM \$3.70
	right	CM6	5,100	#017338RM \$3.70
7/16"	left	CML7	6,402	#017339LM \$5.45
	right	CM7	6,402	#017339RM \$5.45
1/2"	left	CML8	8,386	#017340LM \$6.35
	right	CM8	8,386	#017340RM \$6.35
5/8"	left	CML10	9,813	#017341LM \$10.20
	right	CM10	9,813	#017341RM \$10.20
5/8" x 3/4"	left	RSML10	16,613	#017342LM \$22.30
	right	RSM10	16,613	#017342RM \$22.30
3/4"	left	CML12	14,290	#017343LM \$12.65
	right	CM12	14,290	#017343RM \$12.65



#017342RM

FK 4130 ROD ENDS WITH TEFLON

Hole/Thread	Type	FK #	Static Load Capacity Lbs	Price
3/8"	left	JMXL6T	9,550	#016338LM \$19.95
	right	JMX6T	9,550	#016338RM \$19.95
3/8" x 7/16"	right	HRSMX6T	11,789	#016006RMT \$39.95
7/16"	left	JMXL7T	10,290	#016339LM \$23.95
	right	JMX7T	10,290	#016339RM \$23.95
1/2"	left	JMXL8T	16,242	#016340LM \$27.95
	right	JMX8T	16,242	#016340RM \$27.95
1/2" x 5/8"	left	RSMXL8T	31,420	#016345LM \$31.95
	right	RSMX8T	31,420	#016345RM \$31.95
1/2" x 3/4"	left	RSMXL10-8T	40,590	#016344LM \$61.95
	right	RSMX10-8T	40,590	#016344RM \$61.95
5/8"	left	JMXL10T	17,959	#016341LM \$34.95
	right	JMX10T	17,959	#016341RM \$34.95
5/8" x 3/4"	left	RSMXL10T	40,590	#016342LM \$46.95
	right	RSMX10T	40,590	#016342RM \$46.95
3/4"	left	JMXL12T	28,090	#016343LM \$47.95
	right	JMX12T	28,090	#016343RM \$47.95
3/4" x 7/8"	left	RSMXL12T	55,696	#017561LM \$59.95

All rod ends include jamnuts at no additional charge!



MILD STEEL ROD ENDS

Hole/Thread	Type	Aurora #	Radial Static Load Capacity Lbs			
10/32"	left	CB-3	1,204	#004703LM	\$6.40	
	right	CM-3	1,204	#004703RM	\$6.40	
1/4"	left	CB-4	2,212	#004704LM	\$6.60	
	right	CM-4	2,212	#004704RM	\$6.60	
5/16"	left	CB-5	3,577	#004705LM	\$7.25	
	right	CM-5	3,577	#004705RM	\$7.25	
3/8"	left	CB-6	5,068	#004706LM	\$8.25	
	right	CM-6	5,068	#004706RM	\$8.25	
7/16"	left	CB-7	6,345	#004707LM	\$9.85	
	right	CM-7	6,345	#004707RM	\$9.85	
1/2"	left	CB-8	8,338	#004708LM	\$13.50	
	right	CM-8	8,338	#004708RM	\$13.50	
5/8"	left	CB-10	9,713	#004710LM	\$18.25	
	right	CM-10	9,713	#004710RM	\$18.25	
5/8" x 3/4"	left	XB-10	16,565	#004810LM	\$39.50	
	left	XB-10T	16,565	#004810LMT*	\$44.95	
	right	XM-10	16,565	#004810RM	\$39.50	
	right	XM-10T	16,565	#004810RMT*	\$44.95	
3/4"	left	CB-12	14,207	#004712LM	\$24.95	
	right	CM-12	14,207	#004712RM	\$24.95	
3/4"	left	MB-12T	11,518	#004812LM	\$44.95	
	right	MM-12T	11,518	#004812RM	\$44.95	

4130 ROD ENDS - 3 PIECE DESIGN WITH TEFLON

Hole/Thread	Type	Aurora #	Radial Static Load Capacity Lbs			
3/8"	left	AB-6T	9,544	#004906LM	\$28.95	
	right	AM-6T	9,544	#004906RM	\$28.95	
3/8" x 7/16"	right	HXAM-6T	11,781	#005006RMT	\$68.95	
3/8" x 7/16"	left	RXAB-6T	17,508	#005106LM	\$56.50	
	right	RXAM-6T	17,508	#005106RM	\$56.50	
7/16"	left	AB-7T	10,285	#004907LM	\$34.95	
	right	AM-7T	10,285	#004907RM	\$34.95	
7/16" x 1/2"	left	RXAB-7T	22,760	#005107LM	\$63.50	
	right	RXAM-7T	22,760	#005107RM	\$63.50	
1/2"	left	AB-8T	16,238	#004908LM	\$40.95	
	right	AM-8T	16,238	#004908RM	\$40.95	
1/2" x 3/4"	left	XAB-8T-2	40,572	#018975	\$80.95	
	right	XAM-8T-2	40,572	#018974	\$80.95	
1/2"	left	RAB-8T	15,500	#018178	\$64.95	
	right	RAM-8T	15,500	#018177	\$64.95	
1/2" x 5/8"	left	RXAB-8T	30,579	#005108LM	\$78.50	
	right	RXAM-8T	30,579	#005108RM	\$78.50	
5/8"	left	AB-10T	17,955	#004910LM	\$53.95	
	right	AM-10T	17,955	#004910RM	\$53.95	
5/8" x 3/4"	left	XAB-10T	40,572	#005010LM	\$74.50	
	right	XAM-10T	40,572	#005010RM	\$74.50	
5/8"	left	RAB-10T	17,148	#005060LM	\$83.50	
	right	RAM-10T	17,148	#005060RM	\$83.50	
5/8" x 3/4"	left	RXAB-10T	39,674	#005110LM	\$99.95	
	right	RXAM-10T	39,674	#005110RM	\$99.95	
3/4"	left	AB-12T	28,081	#004912LM	\$74.95	
	right	AM-12T	28,081	#004912RM	\$74.95	



STAINLESS STEEL POLY-BUSHED ROD ENDS

Size	Type			
1/2" x 5/8"	right	#005302	\$45.95	
5/8" x 3/4"	right	#005300	\$54.95	
5/8" x 3/4"	left	#005301	\$54.95	

MILD STEEL FEMALE ROD ENDS

Economy Series

Size	Type	Aurora#	Radial Static Load Capacity Lbs		
10/32"	right	CW-3	1531	#004703RF	\$6.30
1/4"	right	CW-4	2539	#004704RF	\$6.50
5/16"	right	CW-5	3133	#004705RF	\$6.60
3/8"	right	CW-6	3915	#004706RF	\$7.85
7/16"	right	CW-7	4218	#004707RF	\$10.05
1/2"	right	CW-8	6660	#004708RF	\$13.60
	left	CG-8	8386	#004708LF	\$13.95

Precision Series

Size	Type	Aurora#	Radial Static Load Capacity Lbs		
10/32"	right	MW-3	2079	#004803RF	\$8.95
1/4"	right	MW-4	3208	#004804RF	\$9.75
5/16"	right	MW-5	3824	#004805RF	\$10.25
3/8"	right	MW-6	5087	#004806RF	\$11.95
7/16"	right	MW-7	6385	#004807RF	\$17.95
1/2"	right	MW-8T	9096	#004808RFT*	\$25.95

*T denotes teflon coated



All rod ends include jamnuts at no additional charge!

ALUMINUM ROD ENDS

Size	Type	Aurora#	Radial Static Load Capacity Lbs		
1/2" x 5/8"	left	XALB-8	14,889	#018916	\$45.95
	right	XALM-8	14,889	#018915	\$45.95

HIGH-ANGULARITY ROD ENDS

Size	Type			
1/2"	left	#018845	\$11.95	
1/2"	right	#018844	\$11.95	



SOLID ROD ENDS / CHROMOLY

Commonly used for ladder bar suspensions.

Size	Type			
5/8" x 3/4"	right	#005404	\$23.95	
5/8" x 7/8"	right	#017489	\$23.95	



JAMNUTS

Set of 4

Size	Right Hand	Price	Left Hand	Price
10/32"	#019726	\$1.95	#019727	\$2.95
1/4"-28	#019728	\$1.95	#019729	\$3.50
5/16"-24	#019730	\$1.95	#019731	\$3.95
3/8"-24	#019732	\$2.25	#019733	\$4.95
7/16"-20	#019734	\$2.25	#019735	\$5.95
1/2"-20	#019736	\$2.25	#019737	\$6.95
5/8"-18	#019738	\$3.50	#019739	\$7.95
3/4"-16	#019740	\$4.50	#019741	\$8.95



HARDWARE



LEFT HAND TAPS

1/4" - 28	#019898	\$8.95
5/16" - 24	#019899	\$9.95
3/8" - 24	#019599	\$12.95
7/16" - 20	#019900	\$16.95
1/2" - 20	#019600	\$20.95
5/8" - 18	#019901	\$29.95
3/4" - 16	#019601	\$40.95
7/8" - 14	#017497	\$58.95

RIGHT HAND TAPS

1/4" - 28	#017136	\$5.95
5/16" - 24	#017137	\$6.95
3/8" - 24	#017138	\$7.95
7/16" - 20	#017139	\$11.95
1/2" - 20	#017140	\$12.95
5/8" - 18	#017141	\$20.95
3/4" - 16	#017142	\$28.95
7/8" - 14	#017496	\$38.95



TUBE END ADAPTERS - CHROMOLY

Thread, Tube O.D. & Wall	Left Hand	Right Hand
1/4" x 28, 1/2" x .058"	#019767L \$5.50	#019767R \$5.50
5/16" x 24, 1/2" x .058"	#019768L \$5.50	#019768R \$5.50
5/16" x 24, 5/8" x .058"	#002900L \$5.75	#002900R \$5.75
3/8" x 24, 5/8" x .058"	#002901L \$5.95	#002901R \$5.95
3/8" x 24, 3/4" x .058"	#002902L \$6.35	#002902R \$6.35
3/8" x 24, 7/8" x .058"	#015000L \$6.95	#015000R \$6.95
7/16" x 20, 7/8" x .058"	#002903L \$6.95	#002903R \$6.95
1/2" x 20, 7/8" x .058"	#002904L \$6.95	#002904R \$6.95
1/2" x 20, 1" x .058"	#002905L \$9.95	#002905R \$9.95
1/2" x 20, 1" x .065"	#018719L \$9.95	#018719R \$9.95
1/2" x 20, 1-1/8" x .058"	#019230L \$11.50	#019230R \$11.50
1/2" x 20, 1-1/8" x .083"	#019228L \$11.50	#019228R \$11.50
5/8" x 18, 1" x .058"	#002906L \$9.95	#002906R \$9.95
5/8" x 18, 1 1/8" x .083"	#002908L \$11.50	#002908R \$11.50
5/8" x 18, 1 1/4" x .065"	#017014L \$16.95	#017014R \$13.95
5/8" x 18, 1 1/4" x .095"	#017312L \$16.95	#017312R \$13.95
3/4" x 16, 1 1/8" x .083"	#002909L \$11.50	#002909R \$11.50
3/4" x 16, 1 1/4" x .058"	#002910L \$16.95	#002910R \$13.95
3/4" x 16, 1 1/4" x .095"	#002911L \$16.95	#002911R \$13.95
3/4" x 16, 1 3/8" x .095"	#019058L \$17.95	#019058R \$14.95
3/4" x 16, 1 1/2" x .120"	#019060L \$22.95	#019060R \$19.95
7/8" x 14, 1 3/8" x .095"	#017560L \$17.95	#017560R \$14.95

* Indicates left-hand includes machined hex nut.

NOTE: Tube end adapters must be Tig welded.

CLEVISES

CLEVIS - WELD IN

Fits 5/16" tube, 5/32" slot, 3/16" hole	#004301	\$8.75
Fits 3/8" tube, 1/8" slot, 3/16" hole	#019756	\$8.75
Fits 1/2" tube, 1/8" slot, 1/4" hole	#019757	\$10.95
Fits 5/8" tube, 1/8" slot, 5/16" hole	#004404	\$10.95
Fits 3/4" tube, 3/16" slot, 5/16" hole	#004405	\$11.95
Fits 7/8" tube, 3/16" slot, 3/8" hole	#004406	\$12.95
Fits 1" tube, 3/16" slot, 3/8" hole	#004407	\$13.95
Fits 1" tube, 1/4" slot, 3/8" hole	#015002	\$13.95
Fits 1 1/8" tube, 1/4" slot, 3/8" hole	#018830	\$15.95



CLEVIS - THREADED STUD

3/8"-24 RH, 3/16" slot, 5/16" hole	#004401	\$17.95
1/2"-20 RH, 1/4" slot, 3/8" hole	#004402	\$17.95
5/8"-18 RH, 3/8" slot, 3/8" hole	#004403	\$37.50

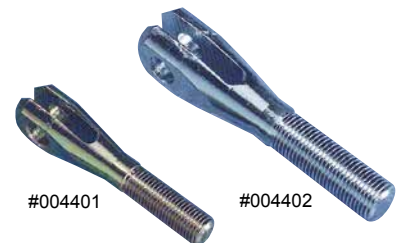

QUICK RELEASE PINS

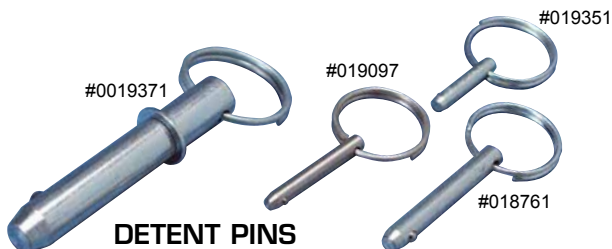

DETENT PINS

Size	Grip Length	Part No.	Price
3/16"	5/8"	#019351	\$1.85
	1 1/4"	#019097	\$1.95
1/4"	1 1/4"	#018761	\$2.50
3/8"	2"	#019225	\$3.25
1/2"	1 1/2"	#019371	\$4.95

PUSH/PULL PINS

Size	Grip Length	Type	Part No.	Price
3/16"	3/4"	Button	#018211	\$13.95
1/4"	1"	Button	#018059	\$14.95
	1 1/4"	Button	#004518	\$15.95
	2"	T-Handle	#019934	\$20.95
5/16"	1"	Button	#004520	\$16.95
	2"	Button	#004521	\$17.95
3/8"	1"	Button	#004524	\$19.95
	2"	Button	#004526	\$21.95
	3"	Button	#004528	\$22.95
	4 1/2"	Button	#019935	\$24.95
1/2"	2"	Button	#019936	\$25.95
	2 1/2"	T-Handle	#004538	\$35.95



FLUSH MOUNT

- .400 long #004620 \$2.00
- .500 long #004622 \$2.00
- .550 long #019594 \$2.00

Note: Takes #5 spring



#004620

STANDARD SELF-EJECTING

- .400 long #004600 \$2.65
- .450 long #004601 \$2.65
- .500 long #004602 \$2.65
- .550 long #004603 \$2.65
- .600 long #004604 \$2.65

Note: Takes #5 spring



#004600

PRO STOCK STYLE, LARGE

- .500 long #004634 \$2.75
- .550 long #004636 \$2.75

Note: Takes #6 spring



#004634



#004640

DZUS SPRINGS

- .250 #5 #004640 \$.85
- .325 #5 #004642 \$.85
- .250 #6 #004644 \$.85

Note: #5: 1" center to center
#6: 1 3/8" center to center

BUTTERFLY SELF EJECT

- .500 long #018705 \$3.20

Note: Takes #5 spring



#018705

BUTTERFLY FASTENER

- .500 long #017135 \$2.05

Note: Takes #5 spring



#017135

OVAL HEAD FASTENER

- .500 long #018718 \$1.95
- .550 long #019595 \$1.95

Note: Takes #5 spring



#019595

DZUS WASHERS

25 pack. #019272 \$10.95 per pack

#015737



DZUS BACKING PLATES

- Standard #019832 \$1.85
- Large #019833 \$1.85



#019833

DZUS DIMPLING TOOL

Used to dimple aluminum panels when installing flushmount fasteners.

#018703 \$24.95

DZUS SPRING ADJUSTING TOOL - HEAVY DUTY

#015737 \$62.95

DZUS RIVET SMASH TOOLS

- Fixed #019397 \$149.95
- Swivel Head #017065 \$249.95



#019397



#017065

DZUS WRENCHES

- Dzus driver #019025 \$24.95
- Flat style #004690 \$4.50



#019025

#004690



#018756

DZUS PANEL DOUBLER

#018756 \$1.35



#017458

DZUS DRILL FIXTURE

Drill fixture allows for easy location of mounting holes for #5 and #6 dzus fasteners.

#017458 \$19.95

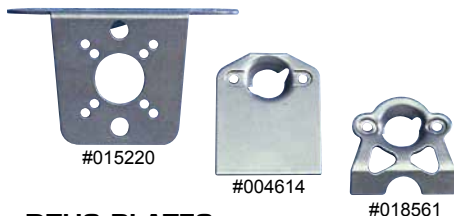

#015220

#004614

#018561

DZUS PLATES

- Standard Weld-on. Takes #5 spring. #004614 \$1.55
- Standard Bolt-on. Takes #5 or #6 spring. #015220 \$2.15
- Lightweight Weld-on. Takes #5 spring. #018561 \$1.65
- Lightweight Weld-on. Takes #6 spring. #018827 \$1.65

#019303



DZUS RIVETS

- 1/8" diameter, 1/4" long soft aluminum.
- Bag of 100-Gold #019303 \$4.25
- Bag of 200-Black #017444 \$16.95



#017419

DZUS RAIL

8 hole aluminum rail for #5 springs. 59-1/2" overall length.

#017419 \$44.95

#017459



ART DZUS INSTALLATION KIT

Includes smash rivet tool, Dzus drill jig, Dzus spring adjuster, dimpling tool, 1/8" double ended drill bit set. #017459 \$259.95



CABLES & HARDWARE

ALLEN HEAD SELF EJECT DZUS

- Standard .500 Long #004550 \$3.15
- Standard .550 Long #004555 \$3.15
- Pro Stock .500 Long #004650 \$3.40
- Pro Stock .550 Long #004655 \$3.40



ART DZUS TRACK PACK ASSORTMENT

- 103 piece kit contains:
- 1 13" x 10" Modular Storage Bin With Map
 - 10 pcs Dzus Standard Self Ejecting .500 Long
 - 10 pcs Dzus Standard Self Ejecting .550 Long
 - 10 pcs Dzus Pro Stock Style Self Ejecting .500 Long
 - 10 pcs Dzus Pro Stock Style Self Ejecting .550 Long
 - 10 pcs Dzus Oval Head .500 Long
 - 10 pcs Dzus Spring .250 #5
 - 10 pcs Dzus Spring .325 #5
 - 10 pcs Dzus Spring .250 #6
 - 10 pcs Dzus Backing Plate Standard
 - 10 pcs Dzus Backing Plate Large
 - 1 pack Dzus Rivets 1/8 X 1/4 Pack of 100
 - 1 Dzus Wrench - Flat Style
- #017476 \$189.95



**BLACK STEEL SELF EJECT DZUS FASTENERS
SLOT & ALLEN HEAD STYLE
PLEASE CALL FOR CURRENT
PRICING & AVAILABILITY**



ALLEN HEAD DZUS WRENCH

- Stubby 3/16" #017424 \$10.95
- Standard 3/16" #017425 \$10.95



MORSE CABLES & ACCESSORIES

CABLE CLAMP SHIMS

- 1" #002817 \$2.95

CABLE CLAMPS

- 1" #002815 \$4.65



#002815

QUICK-RELEASE CABLE CLAMP & BRACKET

- Single #002818 \$10.95
- Dual #019512 \$49.95

#002818



#002810

MORSE CABLE TERMINAL EYE 10-32 CABLE

- 5/16" dia. hole. Length of hole center to barrel end is 1". #002810 \$9.95
- 3/16" ID x 5/16" O.D. reducing bushing for above terminal eye. #002811 \$1.30

MORSE CABLE

Long-lasting, smooth operating push-pull #30 cables with 10-32 threaded ends for shifters, throttle linkage, etc. 1/4"-28 #40 and 5/16"-24 #50 available.

Longer lengths available.

- | | |
|----------------------|----------------------|
| 4ft #002704 \$41.95 | 15ft #002715 \$63.95 |
| 5ft #002705 \$41.95 | 16ft #002716 \$65.95 |
| 6ft #002706 \$51.95 | 17ft #002717 \$65.95 |
| 7ft #002707 \$51.95 | 18ft #002718 \$67.95 |
| 8ft #002708 \$53.95 | 19ft #002719 \$69.95 |
| 9ft #002709 \$55.95 | 20ft #002720 \$69.95 |
| 10ft #002710 \$55.95 | 22ft #002722 \$73.95 |
| 11ft #002711 \$57.95 | 24ft #002724 \$75.95 |
| 12ft #002712 \$59.95 | |
| 13ft #002713 \$61.95 | |
| 14ft #002714 \$61.95 | |



CHUTE CABLE END CAP

Protects cut end of parachute cable. Fits all standard duty 3300/CC230 Morse cables. #017625 \$9.95

#017625



CABLE KNOB THREADED 10-32

Black anodized aluminum knob features ez-grip design, 2" outside diameter and 10/32 female threads. Useful for remote master disconnect switches or any application involving 10/32 threaded cable. #018982 \$34.95



#018982

MORSE CABLE QUICK-RELEASE FITTINGS

10-32 quick-release ball joint, stud is 9/16" long with 1/4"-28 UNF threads. 15/16" from center of stud to end of barrel. Complete with nut and lock washer. Fits series 30 cable #015090 \$7.85



#015090

1/4"-28 quick-release ball joint, stud is 9/16" long with 1/4"-28 UNF threads. 15/16" from center of stud to end of barrel. Complete with nut and lock washer. Fits series 40 cable #015091 \$9.95

10-32 quick-release ball joint, stud is 11/16" long with 5/16"-24 UNF threads. 1 1/8" from center of stud to end of barrel. Complete with nut and lock washer. Fits series 30 cable #015092 \$13.95



HARDWARE & CHASSIS ACCESSORIES

HARDWARE

GRADE 8 BOLTS

Size	Each
1/4" x 1"	\$.40
1/4" x 1 1/2"	\$.45
1/4" x 2"	\$.50
1/4" x 2 1/2"	\$.55
1/4" x 3"	\$.75
5/16" x 1"	\$.45
5/16" x 1 1/2"	\$.50
5/16" x 2"	\$.65
5/16" x 2 1/2"	\$.75
5/16" x 3"	\$.90
3/8" x 1"	\$.50
3/8" x 1 1/2"	\$.65
3/8" x 2"	\$.75
3/8" x 2 1/2"	\$.90
3/8" x 3"	\$ 1.00
7/16" x 1"	\$.70
7/16" x 1 1/2"	\$.90
7/16" x 2"	\$ 1.05
7/16" x 2 1/2"	\$ 1.30
7/16" x 3"	\$ 1.45

GRADE 8 BOLTS

Size	Each
1/2" x 1"	\$.85
1/2" x 1 1/2"	\$ 1.05
1/2" x 2"	\$ 1.35
1/2" x 2 1/2"	\$ 1.65
1/2" x 3"	\$ 2.00
5/8" x 2"	\$ 1.75
5/8" x 2 1/2"	\$ 2.45
5/8" x 3"	\$ 3.05
3/4" x 2"	\$ 2.85
3/4" x 2 1/2"	\$ 3.25
3/4" x 3"	\$ 4.35



GRADE 8 WASHERS

Size	Each
1/4"	\$.25
5/16"	\$.30
3/8"	\$.35
7/16"	\$.40
1/2"	\$.45
5/8"	\$.55
3/4"	\$.65

NYLOCKS

Size	Each
1/4"	\$.25
5/16"	\$.30
3/8"	\$.35
7/16"	\$.45
1/2"	\$.45
5/8"	\$.75
3/4"	\$ 1.25



12-POINT HARDENED NON-LOCKNUTS

Size	Each
1/4" x 28	#017129 \$ 1.95
5/16" x 24	#017130 \$ 1.95
3/8" x 24	#017131 \$ 2.00
7/16" x 20	#017132 \$ 2.50
1/2" x 20	#017133 \$ 3.50

AN WASHERS

Size	Part #	Each
3/16"	#019812	\$.20
1/4"	#019813	\$.25
5/16"	#019814	\$.30
3/8"	#019815	\$.35
7/16"	#019816	\$.40
1/2"	#019817	\$.45
5/8"	#019818	\$.60
3/4"	#019819	\$ 1.05

10/32 STAINLESS (BOX OF 100)

BUTTON HEAD SCREWS	
10/32" x 3/4"	\$ 19.95
10/32" x 1"	\$ 23.95
COUNTERSUNK SCREWS	
10/32" x 3/4"	\$ 19.95
10/32" x 1"	\$ 23.95
FLAT WASHERS	\$ 5.95
NYLOCKS	\$ 12.95

CHASSIS & PIT ACCESSORIES

CHASSIS STABILIZER HOSE

Includes 6' hose extension to permit easy filling from outside the frame of your vehicle.

#019650 \$19.95



#019650



#017628



#017107



#017627

DRAGSTER WHEEL CRADLES

Designed to keep front wheels stable during transportation. The wheel cradle stops all left to right movement in the front without securing the front-end of the vehicle. Two molded through-holes allow the wheel cradle to be semi-permanently mounted to the trailer floor.

#017627 \$179.95 (pair)

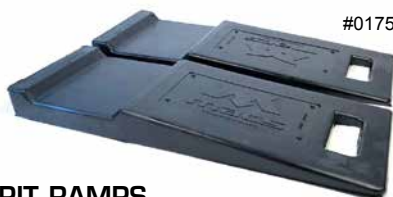

#017570

PIT RAMPS

Made of durable elastomer construction that features detents, to hold most tire sizes steady, and formed hand holes that allow greater convenience when using.

#017570 \$197.95 (pair)



#019829

RATCHET TIE DOWN D-RINGS

Weld-on D-rings (pair)

Mild Steel #019828 \$14.95

Chromoly #019829 \$19.95



#019883

CHASSIS STABILIZER STORAGE POUCH

#019883 \$46.95

CHASSIS STABILIZERS

Protect your vehicles sensitive components from excessive wear while traveling. Chassis stabilizers inhibit vertical movement during transportation to stop damage and wear of chassis and suspension components, electronics, struts, springs, torsion bars and on-board computers. All kits come with a 6' hose kit and a gate valve. Simply slide the deflated stabilizer under the most flexible point in the chassis and inflate. Manufactured with a heavy-duty elastic rubber compound and a high strength internal composite support structure.

Stabilizer with Hose - Rectangular #017628 \$274.95

23.25" x 7" X 1.125" (inflates up to 4")

Stabilizer with Hose - Round #017107 \$314.95

18" x 1.75" (inflates up to 10")

Stabilizer with Hose and Storage Pouch - Round #018981 \$359.95



#019896

CHAMPION ENGINE DIAPER

Universal application for the Sportsman racer with a wet sump pan, includes all mounting hardware and replaceable oil absorbent pad.

Non SFI #019896 \$184.95



SALES@APPLIEDRACING.COM

ORDER ONLINE @ WWW.APPLIEDRACING.COM

NITROUS ACCESSORIES

NITROUS ACCESSORIES

#017051



DIGI-SET TIMER

12-volt delay timer, .01 to 10 second intervals, includes timer, base, clips and wiring diagram.

#017051 \$98.95

#017362



HEAVY DUTY DELAY TIMER

For extreme service applications, includes timer, base and wiring diagram.

#017362 \$129.95



#017390

NITROUS PRESSURE GAUGE

Glycerin filled, 4" diameter, 0-1500 psi with #6 AN adapter.

#017390 \$62.95



#019436

SINGLE NITROUS BOTTLE MOUNTS

Stand-up mount with threaded aluminum rods, laser-cut chromoly bases and rings, includes hardware.

10 Lb #019436 \$129.95

15 Lb #017478 \$156.95



#019798

NITROUS BOTTLES - RED

Includes Max-Flow valve with 1/2" syphon tube with flared pickup, 1-1/2" liquid filled gauge, bottle nut and safety pop-off diffuser.

10 Lb w/#6 bottle nut

019798 \$267.50

15 Lb w/#8 bottle nut

#019799 \$300.50



#019560

DUAL NITROUS BOTTLE MOUNTS

Stand-up mount with threaded aluminum rods, laser-cut chromoly bases and rings, includes hardware.

10 Lb #019560 \$184.95

15 Lb #017479 \$199.95

ART NITROUS BOTTLE & MOUNT 10LB SINGLE

#017483 \$394.95



#017483

ART NITROUS BOTTLE & MOUNT 10LB DUAL

#017484 \$714.95



#017484



#017049

4 IN 1 NITROUS BOTTLE WRENCH

This wrench is a necessity for any nitrous racer. Can be used on the #12 bottle nut, the #8 blow down tube and both #4 or #6 nitrous lines. Its also great to use with any nitrous filling station

#017049 \$49.95

ROLL BAR MOUNT NITROUS SWITCH PANEL

This unit comes with a heavy duty starter button and 6 (20 amp) toggle switches, 2 arming switches and a purge button. Constructed of 4130 chromoly and powder coated for a durable finish. Comes complete with all control panel wiring and lead cable.

#017599 \$349.95



MONDAY - FRIDAY 8AM - 5PM EST
SALES: 1.800.571.3023 TECH: 727.571.3023

SEAT BELTS & MOUNTING COMPONENTS



#018584

CAMLOCK 5 POINT 3" HARNESS

Wrap-around or Bolt-in

Black #018583 **\$164.95**
Blue #018106 **\$164.95**
Red #018584 **\$164.95**

LATCH RELEASE 5 POINT 3" HARNESS

Bolt-in

Black #018956 **\$89.95**



#018956



#019612



#019615

SEAT BELT MOUNTS

Sportsman

Includes mild steel brackets with grade 8 hardware. #019612 **\$16.95**

Pro

Includes chromoly brackets and NAS hardware. #019615 **\$44.95**



#019690

STROUD SEAT BELTS CAMLOCK 5 POINT 3" HARNESS

Wrap-around or Bolt-in

Black #019690 **\$249.95**
Blue #019689 **\$249.95**
Red #019688 **\$249.95**

CAMLOCK 7 POINT 3" HARNESS

Black #017449 **\$249.95**



#019691

LATCH RELEASE 5 POINT 3" HARNESS

Wrap-around or Bolt-in

Black #019691 **\$128.95**



#019885

BILLET HELMET HOOK

For 1-5/8" tubing, black anodized
 #019885 **\$19.95**

FIRE SYSTEMS & ACCESSORIES

NOVEC FIRE SYSTEMS

Rechargeable NOVEC system features DOT approved cylinder, steel tubing, pull-style activator, 15' cable, T-bolt band clamps, engine & interior nozzles, mounting bracket and hardware. S.F.I. 17.1.

5lb System #019980 **\$626.95**

10lb System #019981 **\$824.95**

Ships UPS Ground only.



#019980



#019866

FIRE SYSTEM MASTER SHUT-OFF

Upon activation of the fire system, the pressure in the line enters the cylinder and engages the ram, which automatically turns off the master disconnect switch. Includes cylinder with ram button, mounting tab and center-pivot billet disconnect arm to replace your existing arm.

#019866 **\$78.95**

NOTE: Shown mounted for display only. Fittings, line and switch not included.

EXTINGUISHER MOUNTS

An upgraded mounting system, these packages include two 1-5/8" bar-mount clamps and two bottle mount clamps. No welding required.

5lb Package #019864 **\$184.95**

10lb Package #019865 **\$199.95**



#019864



SAFETY APPAREL

SAFETY APPAREL



#017573

SPARCO SPORT LIGHT PRO JACKET

SFI-5 rated, features soft, breathable fabric and gusseted shoulders for freedom of movement.

Large Black #017573 \$349.95

X-Large Black #017574 \$349.95

2X-Large Black #017575 \$349.95

** For built-in arm restraints add \$59.00*



#017576

SPARCO SPORT LIGHT PRO PANTS

SFI-5 rated, soft breathable fabric, boot-cut design with internal cuffs, internal pockets and expandable waist.

Large Black #017576 \$295.95

X-Large Black #017577 \$295.95

2X-Large Black #017578 \$295.95

SPARCO SFI-5 SIZING CHART

Size	Chest	Waist**	Hip	Height	Weight
Large	40-43	34-38	41-44	5'10"-6'2"	165-195
X-Large	44-46	38-42	44-47	5'11"-6'3"	190-220
2X-Large	46-48	42-46	47-50	6' & Over	220-250

Waist size is usually about 2" bigger than your jean size

HEAD & NECK RESTRAINT

SIMPSON RACING HYBRID SPORT - SFI 38.1

The Hybrid Sport features a lightweight design, and the DuPont carbon/polymer construction provides maximum comfort and maneuverability with superior strength. All hybrids come race ready. Low profile design disappears into the seat when worn and allows for easy in and out of the race car, eliminating the danger of becoming caught in other gear.

Includes M61 Quick Release/Dual End Tether Kit.

Medium #017631 \$704.95

Large #017632 \$704.95

X-Large #017633 \$704.95

** For seat belt anchor system add \$41.00*



#017631

M6 QUICK RELEASE HELMET ANCHOR KIT

For use with M61 Dual End Tether. Kit can be used on both SA and SAH style helmets. Anchor kit (with nut washers) is fully SFI approved.

#017634 \$75.95 (pair)



#017634

CARBON FIBER SHEETS

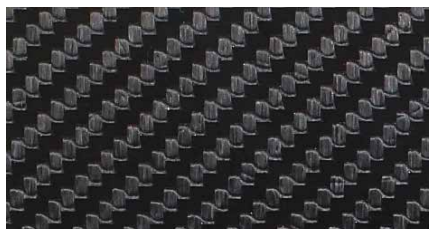

#017070

CARBON/GLASS SHEET

Made with fire resistant resin. For fabricating interior panels, ships UPS.

4' x 8' Sheet #017070 \$664.95

CARBON FIBER SHEET

True carbon fiber sheet. Dry vacuum pressed gloss finish. For fabricating interior panels, ships UPS.

24" x 39" Sheet #017531 \$179.95

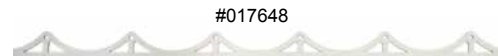

#017648

LIGHTWEIGHT MOUNTING STRIP

Features a lightweight mild steel design for mounting carbon, aluminum, or any other panels to your chassis. These strips are 48" long, .048" thick, and have 3/16" holes spaced 4" apart.

#017648 \$19.95



ROLL BAR & CAGE KITS

ORDERING - Specify make, model and year of vehicle. A.R.T. has roll bars and cages to fit almost every popular vehicle. If by chance we don't have your specific application we will be glad to build it. Just supply us with the necessary dimensions and we will bend it to your specifications.

SHIPPING - All roll bars and roll cages have to be shipped by truck and must be prepaid.

ROLL BAR KITS

A.R.T. 4-8 point roll bar kits are constructed from 1^{3/4}" x .134 wall mild steel or 1^{3/4}" x .083 wall chromoly tubing. Six 6" x 6" steel floor plates are included for applications where the builder cannot tie into the frame.

NOTE: Final fitting is required with all roll bar/roll cage kits.

4 POINT

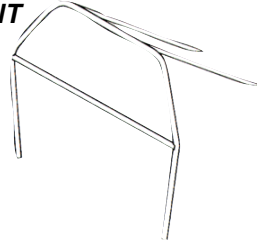

M/S #011454 \$249.95
C/M #019995 \$355.95

6 POINT

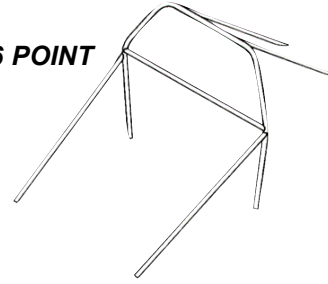

M/S #011456 \$339.95
C/M #019996 \$479.95

8 POINT

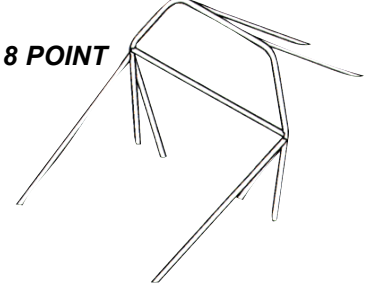

M/S #011458 \$379.95
C/M #019997 \$539.95

All A.R.T. cages include the dash bar & two rocker bars with no additional upgrade charge.

ROLL CAGE KITS

A.R.T. roll cage kits are constructed from the highest quality 1^{5/8}" x .134 wall mild steel or 1^{5/8}" x .083 4130 chromoly tubing (this tubing will pass NHRA sonic check). Six 6" x 6" steel plates are provided for applications where the builder cannot tie into the existing frame.

NOTE: All cages require final fitting. Our 10 and 12 point roll cage kits utilize an "X" from the main hoop to the shock mounting area, greatly triangulating your chassis.

8 POINT

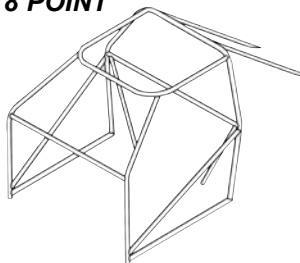

M/S #011468 \$499.95
C/M #018520 \$769.95

10 POINT

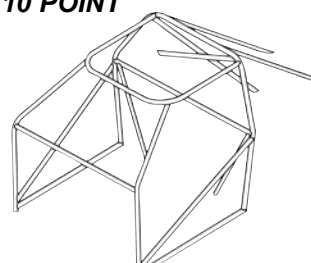

M/S #011470 \$559.95
C/M #018530 \$859.95

12 POINT

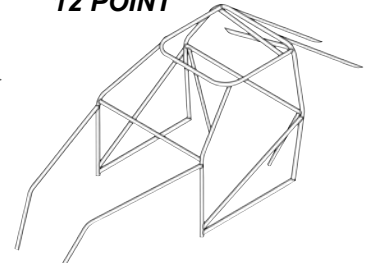

M/S #011472 \$624.95
C/M #018531 \$979.95

FUNNY CAR CAGE KITS

Recommended for all full cage cars to provide additional driver safety, and required for cars going faster than 8.50.

1^{5/8}" x .134" M/S #011476 \$214.95
1^{5/8}" x .083" C/M #018532 \$314.95

NOTE: A Funny Car cage and two additional door bars are required for cars going faster than 8.50.

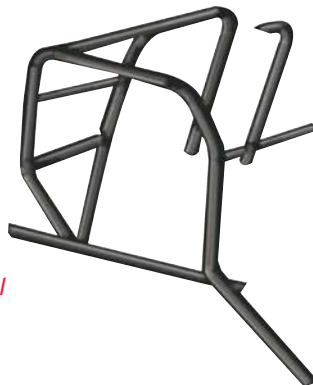

12 POINT PLUS

Kits include 12 point cage, funny car cage, roof diagonal bar, kidney bar and door x-bars.

M/S #019713 \$934.95
C/M #019714 \$1299.95

ROLL CAGE CONVERSION KITS

1^{5/8}" x .134 wall mild steel. Includes halo, rear X-bars, dash bar, window bars, door bars and rocker bars. 12-point conversion adds front strut bars.

10-point Cage Conversion #018792 \$319.95
12-point Cage Conversion #018793 \$394.95

4130 Chromoly roll cage conversion kits also available.



ROLL CAGE & WHEEL TUB COMPONENTS



ART ROLL CAGE SWING OUT DOOR BAR KITS
 1⁵/₈" x .083" #018901 \$89.95
 1⁵/₈" x .134" #018881 \$89.95
 1³/₄" x .134" #018900 \$89.95



ART ROLL CAGE SWING OUT DOOR BAR KITS WITH CLEVIS
 1⁵/₈" x .083 #019702 \$139.95
 1⁵/₈" x .134 #019703 \$139.95
 1³/₄" x .134 #019704 \$139.95

PIPE MASTER TOOLS

Used to create a template for marking the exact radius or angle for precise fits. Provides tighter joints and reduces waste.

1⁵/₈" O.D. #017030 \$51.95
 1³/₄" O.D. #017031 \$56.95



ROLL BAR GUSSET
 #018562 \$.75



SFI 45.1 ROLL BAR PADDING
 Black 3' length #018788 \$25.95



CARBON FIBER TUBE PROTECTORS
 1-1/4" #017117 \$69.95
 1-5/8" #017118 \$69.95
 1-3/4" #017119 \$69.95



ART ROLL BAR PLATE
 1/8" x 6" x 6" mild steel
 #018273 \$7.95



SPLIT-GROMMET TUBE SEALS
 Unique two-piece design enables 360° seal around tube.
For 1-5/8" tube #017156 \$34.95
For 1-3/4" tube #017157 \$34.95

WHEEL TUBS

ART ALUMINUM KITS

Aluminum tubs are aircraft aluminum alloy with .040" tops (thicker material resists rock and dents for lasting appearance with a minimum weight increase) and .040" sides.

36" x 23" #019791 \$179.95
 40" x 23" Beaded #018195 \$179.95
 40" x 23" #018196 \$179.95
 40" x 28" Beaded #018789 \$199.95
 45" x 28" #018708 \$229.95



CARBON / FIBERGLASS

NHRA Approved Carbon Fiber Wheel Tubs. One Piece Construction. Manufactured from carbon fiber, kevlar and fire resistant resin. Composite construction makes tubs extremely light (10 lbs before trimmed). The unique "D" shape design allows the largest tire without sacrificing aero drag. Tough inner liner adds strength while offering protection from rock damage. When attached to the inner quarter panel this tub makes the rear area of the body extremely strong.

10.5
 40" x 24" x 25" #017446 \$949.95
 Pro
 46" x 24" x 29" #019349 \$1049.95

ART STEEL KITS

Steel tubs are .024" thick top and sides, (shipped unassembled) use packaging for templates.

36" x 23" #019792 \$139.95
 40" x 23" Beaded #018212 \$139.95
 Fox Body Mini Tubs '79-'93 #017499 \$129.95



MONDAY - FRIDAY 8AM - 5PM EST
 SALES: 1.800.571.3023 TECH: 727.571.3023

#011660



ART DASH KIT

Includes easy to install rolled and contoured dash with end caps, 6" high instrument/gauge face, 60" wide.

NOTE: Also available in .024 steel.

#011660 \$159.95

#011627

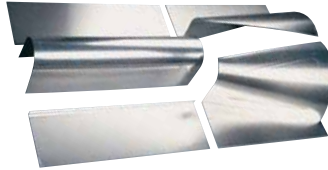

ART TRANS TUNNEL KIT

This design will fit most all transmission and chassis combinations. Easy to install five piece kit consists of left and right 30" long trans tunnel halves and 3 piece driveshaft cover. Front tunnel opening is 20" wide x 14" tall. Overall tunnel dimensions are 28" wide x 30" long. Driveshaft cover is 10" tall, 28" wide x 36" long.

#011627 \$199.95

ART FLOOR PAN KIT

Contains two front floor pans measuring 24" x 60" and two rear pans measuring 24" x 30" Trim to fit.

#011632 \$159.95

DOOR PANEL FASTENER KIT

Includes all necessary hardware and components to allow quick & easy removal of panel for access to door operating assemblies. Includes sufficient hardware for two doors.

#019781 \$59.95



#019781

#011647



ART REAR BULKHEAD KIT

Required by all sanctioning bodies. Partitions passenger compartment from trunk area where fuel tank is mounted to give added protection in case of fire. Three piece kit with bracing. Center panel measures 20" tall x 32" wide. Side panels measure 10" tall x 24" wide.

#011647 \$79.95

ART REAR FLOOR KIT

Designed to work with rear subframes (ladder bar or 4 link). Nine piece kit contains all necessary pieces to "Tin" the rear of most cars. Pieces are oversized and can be trimmed for a custom fit. Panels are beaded for appearance and strength and cover from the crossmember/rear seat area to the rear bumper. Wheel tubs not included.

2" x 3" Ladder Bar #011640 \$299.95

2" x 3" 4 Link #011641 \$299.95

NOTE: This kit can be used with 20" - 30" frame rail widths.



#011636

ART REAR DRIVESHAFT TUNNEL RECEIVER PANEL

This vertical panel goes at the rear of the drivers compartment on the 4 Link uprights. It has a 10" high x 1/2" wide flange (8" across opening that allows the driveshaft tunnel to rest).

#011636 \$79.95

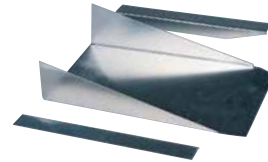

#011650

ART FUEL TANK SUMP COVER

Most sanctioning body rules require that the bottom of the fuel tank be protected from debris with an enclosure such as this one. Easy to install, three pieces. Overall dimensions are 12" long, 6" wide, 3 1/4" tall.

#011650 \$29.95

#011648

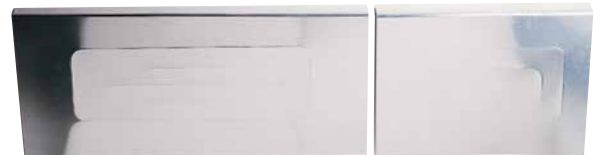

ART DOOR & QUARTER PANEL KIT

This design will fit almost every car. Door panels measure 22" x 50". Quarter panels measure 22" x 30". They feature a rolled top and flange plus beading for the "Professional" look! Kit includes two door panels and two quarter panels.

#011648 \$199.95



#011625

ART FIREWALL KIT

Firewall itself is 24" x 60" and is designed to be trimmed to your car. Also included are cowl cap and door/A-pillar caps.

NOTE: Also available in .024 steel.

#011625 \$179.95



#011641



WINGS & MOUNTING COMPONENTS



ART CLECO KIT
 Kit includes: pliers, 20 -1/8" holders, 10 - 3/16" holders, 4 side grips.
#006255 \$64.95

INDIVIDUAL CLECO COMPONENTS

Cleco pliers, each
#011655 \$12.50
1/8" Cleco holders, package of 10
#011652 \$12.95
3/16" Cleco holders, package of 10
#011654 \$12.95
Cleco side grips, each
#011656 \$4.95

#019840



ADJUSTABLE RIVET SPACER

Equally spaces up to 10 holes between two given points.
#019840 \$37.95



#019824

RIVET BITS

1/8" diameter, double-ended, set of 3
#019824 \$13.95

#019823



RIVETS

1/8" diameter, max. 1/4" grip, pack of 250

Aluminum #019822 \$13.95
Steel #019823 \$13.95

Includes integral naca ducts

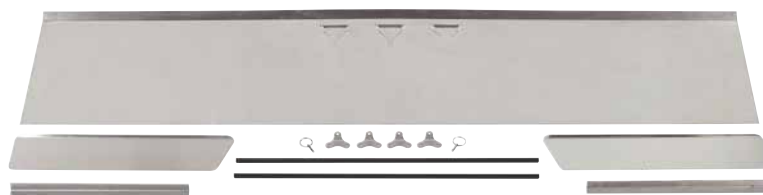

#011550

UNIVERSAL NON-ADJUSTABLE WING

Includes .063 aluminum wing with naca ducts, spill plates, two non-adjustable strut rods with formed aluminum bumper brackets, all hardware and instructions. Can be trimmed to fit your application.

14" x 60" #011550 \$199.95

Includes integral naca ducts

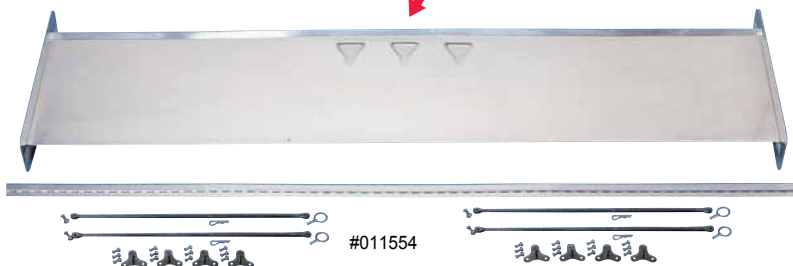

#011554

UNIVERSAL ADJUSTABLE WING

Includes .063 aluminum wing, with naca ducts, spill plates, hinge, four adjusting rods, chromoly bumper brackets, quick-release pins, all necessary hardware and instructions. Can be trimmed to fit your application.

14" x 60" #011554 \$274.95



#011560

ART WING STRUT SUPPORT COMPONENTS

A.R.T. offers wing strut kits that allow you to choose between fixed length wing struts or adjustable wing struts. Adjustable struts utilize slip fit/clevis pin design and mini clevis.

Non-adjustable struts, set of 2
#011560 \$89.95



#011562

Adjustable strut rods with release pins, set of 4
#011562 \$179.95

#019947



#011566



Universal bumper/wing brackets (aluminum), each
#019947 \$3.95

"Pro" bumper brackets (4130), welded assembly, also available unwelded **#011566 \$10.95**



#017166

CARBON/FIBERGLASS WING

Main body features radiused trailing edge, 16" at center and 13" at sides. Includes spill plates with mounts, hinge and hardware. 16" x 63" overall, can be trimmed to fit your application.

Without strut rods #017166 \$499.95

With four adjustable strut rods, hinge, mounting plates, pins and hardware. #017167 \$699.95



SEATS, HOOD SCOOP MOUNTS & GAUGES



#019437

ART CENTER HOOD SCOOP MOUNT

Designed to mount your scoop to the center of a single Dominator style carburetor. Includes hardware, mounting tube and Dzus components with rivets.

#019437 \$19.95

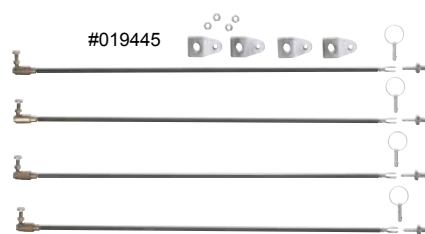

#019445

SIDE HOOD SCOOP MOUNT

Mount your scoop to the manifold the way the Pros do, utilizing 4-point attachment and allowing unrestricted airflow. Includes four rods with quick-release hardware and mounting brackets.

#019445 \$104.95



#019460

ART CARBURETOR AIR PAN

This tray incorporates a raised and rolled inlet providing better airflow dynamics and eliminating additional modification for needle & seat clearance. Measures 16" wide, 24" long with centered inlet. For Holley Dominator with 7⁹/₁₆" neck.

#019460 \$39.95

DRIVER SEATS & MOUNTS



#019449

PRO STOCK CARBON-FIBERGLASS SEAT

A proven design utilizing reinforced fiberglass and true carbon fiber materials. This seat offers both safety and comfort. 15" wide inside seat bottom, 21" across the shoulders, and 31" tall at 90°. This seat can be installed with a wide range of layback angles to accommodate your specific application or preference.

#019449 \$549.95



#018726

ALUMINUM SEAT

Constructed of .100 thick 5052 grade aluminum. Features a reinforced head rest and a raised front for added leg and thigh support. Seat comes standard with double shoulder and sub-belt openings to accommodate all seat belt systems. The seat can be mounted in a wide range of layback angles from 10° to 20°.

17" wide x 35.5" tall.

#018726 \$199.95

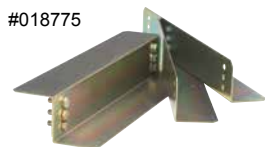

#018775

SEAT MOUNT KIT

Universal bolt-in style, adjusts seat for both height and angle.

#018775 \$54.95



#019606

4" HEADREST WITH MOUNT

Includes chromoly tubing, mounting plate and padded vinyl cover.

#019606 \$34.95

SEAT COVER - ALUMINUM SEAT

Fully padded black vinyl quilted cover snaps on for easy removal and replacement. Belt openings are double stitched for added strength, while the contoured high-density foam provides complete rib and leg support for added comfort.

#018727 \$159.95



#018727

AIR GAUGES



#017127

2-1/2" GLOW-IN-THE-DARK

0-15 x 1/5 PSI with thumb-bleed.

#017127 \$69.95



#017128

2-1/2" GLOW-IN-THE-DARK

0-60 x 1 PSI with thumb-bleed.

#017128 \$69.95



#017126

4" GLOW-IN-THE-DARK

0-15 x 1/2 PSI with thumb-bleed.

#017126 \$89.95

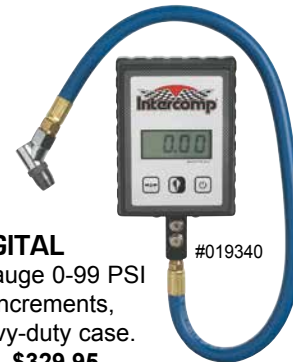

#019340

PRO DIGITAL

Digital gauge 0-99 PSI by 1/10 increments, with heavy-duty case.

#019340 \$329.95

TIRES & WHEELS

We offer the complete line of Goodyear, Hoosier and Mickey Thompson tires. Call for prices.



Racing tires are specifically designed and compounded for racing only.
RACING TIRES ARE ILLEGAL FOR STREET USE.

We also offer a full line of drag radial tires



**WELD FRONT V-SERIES
STRANGE SPINDLE MOUNT
BLACK ANODIZED 15"**

Weld V-Series Strange Spindle Mount, 15 x 3.5, 1.75 back space, black anodized, includes bearing, race, seal kit with valve stem and cap.
#017438 **\$889.95**

**STRANGE SPINDLE MOUNT
BLACK ANODIZED 17"**

Weld V-Series Strange Spindle Mount, 17 X 3.5, 1.75 back space, black anodized, includes bearing, race, seal kit with valve stem and cap.
#017441 **\$889.95**

**ANGLIA SPINDLE MOUNT
BLACK ANODIZED 15"**

Weld V-Series Anglia Spindle Mount, 15 X 3.5, black anodized, includes bearing, race, seal kit with valve stem and cap. Lamb spindle bearings available at additional charge.
#017439 **\$889.95**

**ANGLIA SPINDLE MOUNT
BLACK ANODIZED 17"**

Weld V-Series Anglia Spindle Mount, 17 X 3.5, black anodized, includes bearing, race, seal kit with valve stem and cap.
#017440 **\$909.95**

**15 x 3.5 HUB MOUNT
BLACK ANODIZED 15"**

Weld V-Series 15 X 3.5, 5 X 4.75 bolt circle, 1.75 back space, black anodized.
#017442 **\$767.95**

ART RIM SCREW TEMPLATE

Unique design allows 8 or 16 rim screws to be equally spaced on 15" wheels.

#019660 **\$34.95**

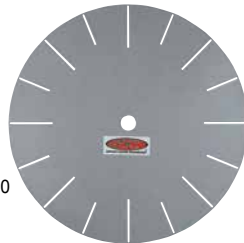

#019660

We offer the full line of Weld Racing, call for pricing

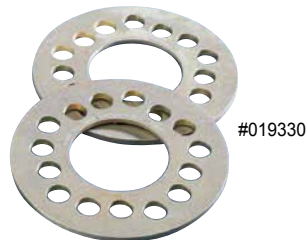

#019330



#019331

WHEEL SPACERS

Billet Aluminum 1/4" spacers (pair) fit 11/16" drive studs for 5 on 4 1/2, 4 3/4 & 5 bolt circle wheels.

#019330 **\$69.95**

1/2" spacers (pair) fit 11/16" drive studs for 5 on 4 1/2, 4 3/4 & 5 bolt circle wheels.

#019331 **\$98.00**



#019014

RIM SCREWS

Pack of 35 #019014 **\$10.50**

VALVE STEMS

Front

#018207 **\$9.95** each

Weld 2.0 dragster wheel

#019811 **\$6.95**

Rear

#018185 **\$2.95** each



#018185

TIRE COVER

30" tall x 42" wide, includes suction cups.

#017552 **\$49.95**

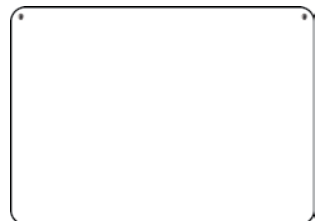



T-SHIRTS

White, Heather Gray, Black, Pink or Red, 50/50 blend
Small, Medium, Large, X-Large, 2X-Large & 3X-Large
\$19.95



HOODIES

Black only, 50/50 blend.
Small, Medium, Large, X-Large,
2X-Large & 3X-Large
#017558 \$39.95



FLEX-FIT HATS

Black, Large/X-Large
#017557 \$24.95



Back



BANNER

Premium high quality indoor/outdoor banner.
Water resistant and UV resistant. Double
stitched edge along all sides of the banner
6ft x 3ft with metal grommets.
\$29.95





APPLIED RACING TECHNOLOGY
4400 118th Avenue North
Suite 104
Clearwater, FL 33762

1.800.571.3023

ORDERS ONLY LINE
Mon. - Fri. 8 am-5 pm



email: sales@appliedracing.com

24-Hour Fax Line: (727) 572-8698

Info & Tech Line: (727) 571-3023

Presorted
Standard
U.S. Postage
PAID
Tampa, FL
Permit #3875

TRN Performance Rewards

*Get rewarded every time you shop online,
AND have exclusive access to our latest
sales, promotions and new product releases!*

Sign up anytime at www.appliedracing.com

*Create a new account or login to your
existing account when you are ready to
place an online order, **AND THAT'S IT!!!***

*You will now earn reward points back on
every dollar you spend online at
www.appliedracing.com, AND you will
join our exclusive email list!*

*Redeem your reward points as soon as
your next online order, or save them for
a larger discount later!*

\$5.00